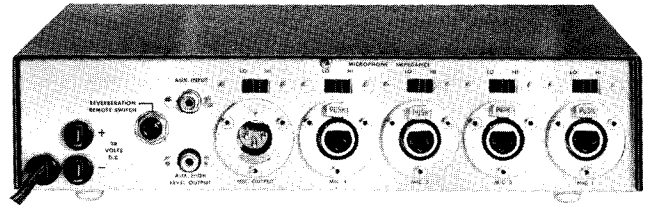
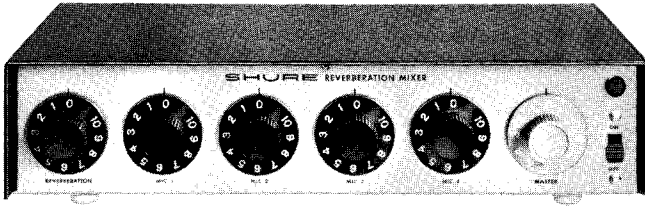

**SHURE**

222 HARTREY AVE., EVANSTON, IL. 60204 U.S.A.

MICROPHONES AND ELECTRONIC COMPONENTS

AREA CODE 312/328-9000 • CABLE: SHUREMICRO

DATA SHEET**MODELS M68RM AND M68RM-2E MICROPHONE MIXERS**

REAR VIEW OF MODEL M68RM

GENERAL:

The Shure Models M68RM and M68RM-2E are four-channel, completely transistorized portable microphone mixers with built-in REVERBERATION for use with sound reinforcement, tape recording, and audio-visual systems.

The Mixers feature:

- Adjustable REVERBERATION to simulate natural reverberation or echoes of a large concert hall.
- Phone jack provided for use with remote reverberation ON-OFF switch.
- Four microphone inputs with individual slide switches mounted on rear panel for selection of low impedance (balanced or unbalanced) or high impedance (unbalanced).
- One high level auxiliary input suitable for tape, tuner, and accessories. (Uses MIC. 4 input.)
- Individual volume controls to balance each of the four inputs.
- Master volume control to simultaneously control level of all inputs.
- High- (unbalanced) or low-impedance (balanced or unbalanced) microphone level output. Impedance selected with slide switch to match the microphone input of associated amplifier.
- High-impedance auxiliary output.
- DC power supply jack. This jack supplies 28 volts dc for use with accessories such as the Model A68P Phono Preamplifier, Model M62V Level-Loc or may be used as power input in connection with the Model A67B Battery Power Supply (accessory).
- Facility for connecting two or more mixers together to obtain additional microphone inputs. For example, two mixers connected together will give a total of seven microphone inputs, or six microphone inputs and one auxiliary input.
- Listing by Underwriters' Laboratories, Inc.; and by Canadian Standards Association as certified. (Applies to Model M68RM).

SPECIFICATIONS

Gain: At 1,000 Hz

INPUTS	OUTPUTS		
	Low Imp. Mic.	High Imp. Mic.	High Imp. Aux.
Low Imp. Mic. 5 mV produces	+4 dB .8 mV	+28 dB 13 mV	+56 dB 320 mV
High Imp. Mic. 5 mV produces	-18 dB .63 mV	+6 dB 10 mV	+34 dB 250 mV
Aux. 50 mV produces	-38 dB .63 mV	-14 dB 10 mV	+14 dB 250 mV

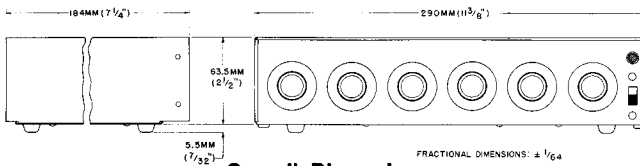

Overall Dimensions
FIGURE A

Frequency Response:

The frequency response is flat ± 3 dB from 40 Hz to 20,000 Hz

Hum-Noise:

70 dB below rated output. (Aux. Output)

Equivalent Input Noise:

150 ohm source, 123 dB below 1 volt, at full gain.

Input Impedance:

Microphone inputs suitable for high- or low-impedance dynamic, ribbon, or condenser microphones. Auxiliary—50,000 ohms.

Recommended Load Impedance:

Low-impedance microphone. 25 to 600 ohms
High-impedance microphone. 20,000 ohms or greater
Auxiliary high-impedance. . . .50,000 ohms or greater

Distortion:

Less than 1% total harmonic distortion when low-impedance microphone output is at 10 mV level, high-impedance microphone output is at 100 mV level, and Aux. high-impedance output is at 1.0 volt level.

Phase:

All microphone inputs and outputs are in phase. Aux. Input and Output are out of phase with Pin 3 of the microphone connectors.

Output Clipping Level:

Output	Min. Clipping Level
Mic. Low Impedance	60 mV
Mic. High Impedance	.85V
Aux. High Impedance	4.0V

Operating Voltage:

Model M68RM: 120 volts $\pm 10\%$, 50/60 Hz
Model M68RM-2E: 220-260 volts, 50/60 Hz

Temperature Range:

Operating: -7°C to 57°C (20°F to 135°F)
Storage: -29°C to 71°C (-20°F to 160°F)

Dimensions:

See Figure A.

Weight:

2.33 Kg (5 lb, 2 oz)

INSTALLATION:**CONNECTION BETWEEN COMPONENTS**

For balanced-line connection use two-conductor, shielded, low-capacity cable. For unbalanced (high-impedance) connection, use single-conductor, shielded, low-capacity cable.

GROUNDING

If there should be objectionable hum, connect the metal chassis of the mixer to a good ground such as a metal frame of a wall outlet or a water or steam pipe. This is normally accomplished automatically through the ground wire of the power cord.

INPUT CONNECTIONS

Note: Before using mixer remove shipping screw (located at top of chassis) holding small tag.

Microphones: A maximum of four low- or high-impedance dynamic, ribbon or condenser microphones may be connected to receptacles marked MIC. 1, MIC. 2, MIC. 3, MIC. 4. The inputs are designed for low-impedance microphones with 25 to 600 ohms impedance or high-impedance microphones. Both low-impedance and high-impedance microphones may be used simultaneously with the M68RM. The unit is not recommended for use with crystal or ceramic microphones. The impedance is selected by a slide switch above each input receptacle. The input receptacles are professional three-pin female audio connectors.† See Figure B for low- and high-impedance connections to receptacle.

Note: Some condenser microphones produce very high output signals which may overload the input of a mixer.

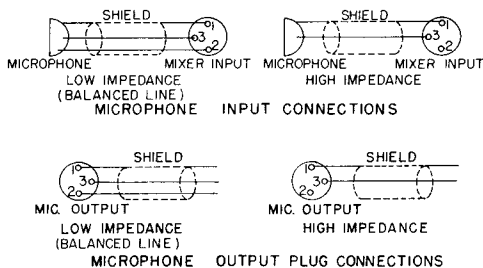

Microphone Connections
FIGURE B

Auxiliary: The phono jack on the rear of the panel marked AUX. INPUT will accept output from a high-level source such as a tape recorder, AM-FM tuner, or output from the Model A68P Phono Cartridge Pre-amplifier (accessory). In this case use MIC. 4 gain control to control volume of Auxiliary Input. (Use of this jack automatically disconnects the MIC. 4 receptacle.)

OUTPUT CONNECTIONS

Microphone: The receptacle marked MIC. OUTPUT is a dual-impedance output selected by the switch above the receptacle. This output is the "mixed" output of all the input sources and is designed to work into a 25- to 600-ohm MIC. line or input, or into a high-impedance amplifier or tape recorder microphone input. The receptacle is a professional three-pin male audio connector.† See Figure B for output receptacle connections.

Auxiliary: The phono jack marked AUX. HIGH LEVEL OUTPUT is a high-impedance, high-level output designed primarily to feed a power amplifier requiring 0.5 to 2 volts or the auxiliary or tuner input of an amplifier or tape recorder.

Accessory 28-volt DC: The terminals marked 28 VOLTS DC + and (-) provide 28 volts dc for accessories such as the Model A68P Phono Cartridge Pre-amplifier or the M62V Level-Loc. The jacks are also used as a power input when using the Model A67B Battery Power Supply (accessory).

REVERBERATION

The blue control knob (on front panel) marked REVERBERATION is used to adjust the amount of reverberation for the desired effect.

The standard phone jack (on back panel) marked REVERBERATION REMOTE SWITCH is used to connect an ON-OFF switch which can be operated through a cable at a remote location to turn REVERBERATION on and off. See Figure C for switch connections.

† Designed to mate with Cannon XL series, Switchcraft A3 (Q.G.) series or equivalent connector. [Shure part 95A407 (male)].

For best results the cable should be low capacity, single conductor, shielded cable with the shield connected to the sleeve of the phone plug.

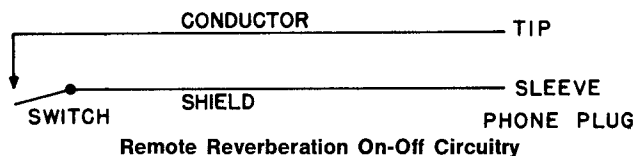

FIGURE C

CAUTION: The M68RM Mixer should not be set on or mounted against a loudspeaker, as vibrations from the speaker cabinet may cause improper operation of reverb. Avoid accidental jarring during operation.

OPERATION

Power: Connect the Microphone Mixer power line cord to a 120 volts ± 10%, 50/60 Hz power source. (220-260 volt, 50/60 Hz for M68RM-2E).

Volume Controls: Each input has a separate gain control for balancing sound levels between microphones. The MASTER gain control simultaneously adjusts the level of all inputs.

The individual gain controls should generally be set near maximum (fully clockwise) and the master gain control adjusted to required output. Individual channel gain controls not being used should be kept at minimum gain (fully counterclockwise).

Identifying Controls: Pressure-sensitive adhesive labels are supplied with the Mixers as a means of identifying the control and recording the control position when optimum results have been obtained. The labels are easily removed when their use is no longer required.

OPTIONAL ACCESSORIES

Battery Power Supply	Model A67B
Output Cable Kit	Model A68C
Locking Panel	Model A68L
Phono Preamp	Model A68P
Rack Panel Kit	Model A68R
Stacking Kit	Model A68S
Handle/Tilt Stand	Model A67H
Attache Carrying Case	Model AC60
Interconnecting Cable	Model A68SC

CONNECTING TWO UNITS TOGETHER

1. A M68RM Reverberation Mixer and a Shure M68 series five-channel Mixer may be combined to give a total of eight microphone channels. In this case, four channels could have reverberation and four channels would NOT have reverberation.

Unit 1—M68RM

Unit 2—M68

- A. Connect the AUX. HIGH LEVEL OUTPUT of UNIT 1 to the AUX. INPUT OF UNIT 2.
- B. Connect the microphones to mixers and set each input gain control to #0 position.
- C. Take the output signal for recorder or PA amplifier from the appropriate output jack on UNIT 2.
- D. Set Master Control UNIT 1 to position #4.
- E. Set AUX. Control on UNIT 2 to position #10.
- F. The Master Control on UNIT 2 is now the Master for all inputs.
- G. Advance Master Control (UNIT 2) to about #5 position and adjust individual microphone controls for proper level. If overall gain is too low or too high the Master Control (UNIT 2) may be adjusted.

H. If an input to the auxiliary channel is needed, such as for a tape recorder or tuner, use AUX. input on UNIT 1. Use Mic. 4 Control on UNIT 1 for level adjustments of the AUX. source. The master gain control for the entire system is the Master Control on UNIT 2.

The Model A68S Stacking Kit includes stacking brackets for attaching the two mixers firmly together plus the required interconnecting cable. The cable is available separately as the Model A68SC.

2. A M68RM Reverberation Mixer and a Shure M68 series five-channel Mixer may also be combined to permit reverberation in seven microphone channels and 1 auxiliary channel.

Unit 1—M68

Unit 2—M68RM

- A. Connect the AUX. HIGH LEVEL OUTPUT on Unit 1 to the AUX. INPUT on Unit 2.
- B. Connect the microphones to mixers and set each input gain control to #0 position.

C. Take the output signal for desired application from appropriate output jack on Unit 2.

D. Set Master Control on Unit 1 to position #4.

E. Set fourth MICROPHONE INPUT Control on Unit 2 to position #10.

F. The Master Control on Unit 2 is now Master for all inputs.

G. Advance Master Control (UNIT 2) to about #5 position and adjust individual microphone controls for proper level. If overall gain is too low or too high the Master Control (UNIT 2) may be adjusted.

Guarantee: This Shure product is guaranteed in normal use to be free from electrical and mechanical defects for a period of one year from the date of purchase. Please retain proof of purchase date. This guarantee includes all parts and labor.

Shipping Instructions: Carefully repack the unit and return it prepaid to the factory. If outside the United States, return the unit to your dealer or Authorized Shure Service Center for repair. The unit will be returned to you prepaid.

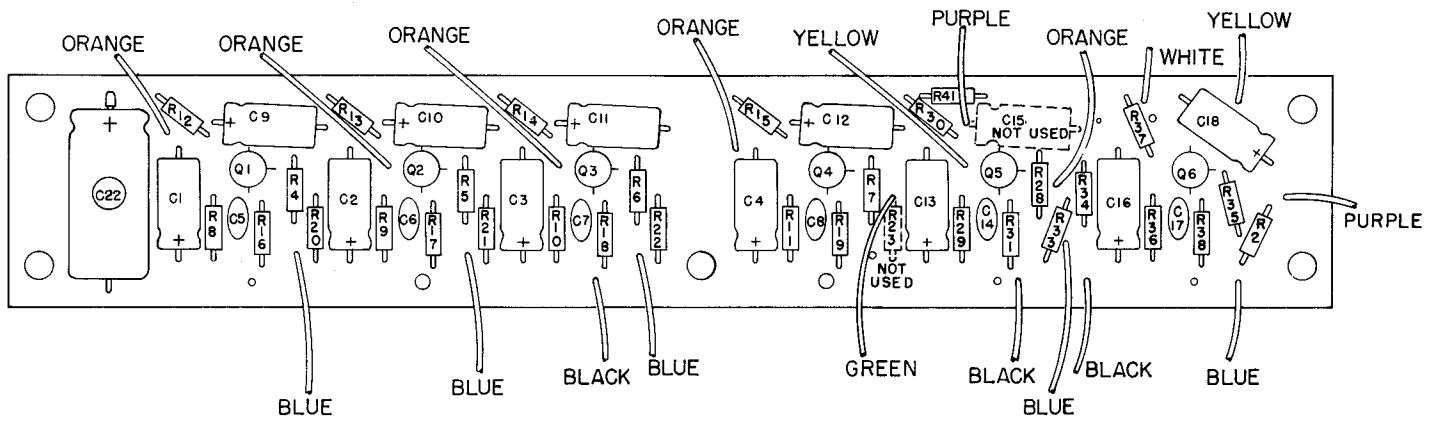

PRINTED CIRCUIT BOARD ASSEMBLY

PARTS LIST			
ITEM	SHURE PART NO. OR KIT	QTY. IN RKC KIT	DESCRIPTION
D1, D2	RKC21	4	DIODE, SILICON, IN4002 OR EQUIVALENT
Q1-Q9	RKC9	4	NPN TRANSISTOR, SILICON, SELECTED HIGH GAIN, LOW NOISE, SIMILAR TO MOTOROLA MPS 6521
R3, R32	46A011	1	POTENTIOMETER, 50K
R24-R27	46A010	1	POTENTIOMETER, 20K
S1-S5	RKC10	4	SWITCH, SLIDE, DPDT
S6	55B103	1	SWITCH, SLIDE, DPDT, 3 AMP.
T1-T5	RKC81	1	TRANSFORMER-SHIELD ASSEMBLY
T6	51A212	1	POWER TRANSFORMER
PL1	RKC45	1	NEON PILOT LIGHT ASSEM. (RESISTOR INTERNAL)
	90A1304	1	REVERBERATION UNIT
PC1	90A1448	1	PRINTED CIRCUIT BOARD ASSEMBLY

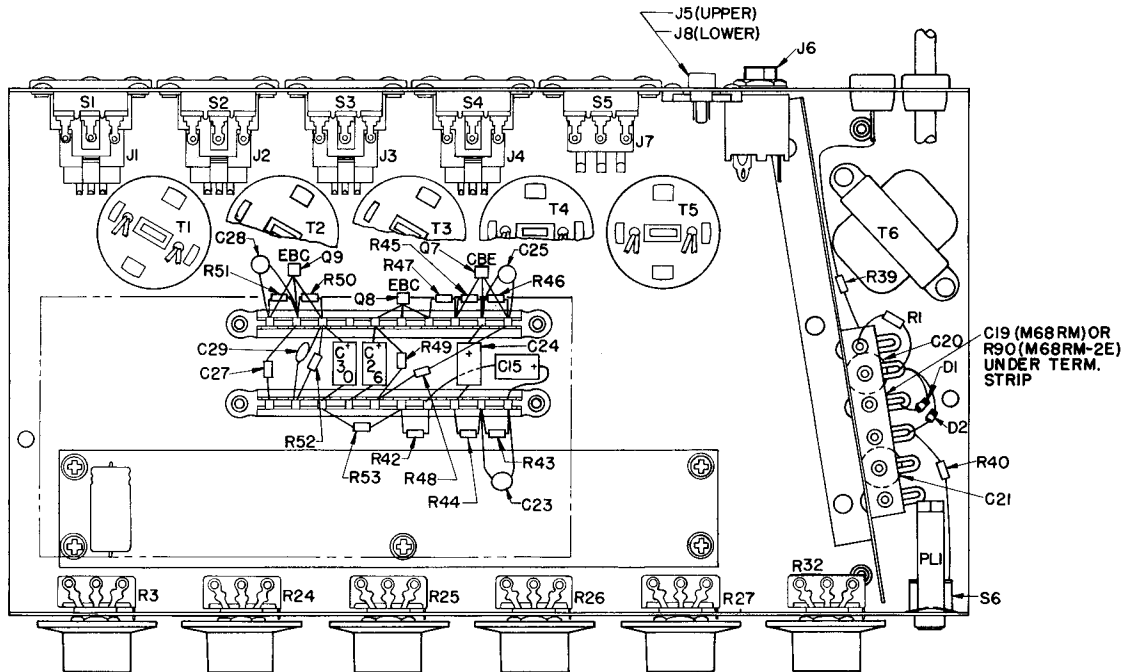

PARTS PLACEMENT

(OVER)

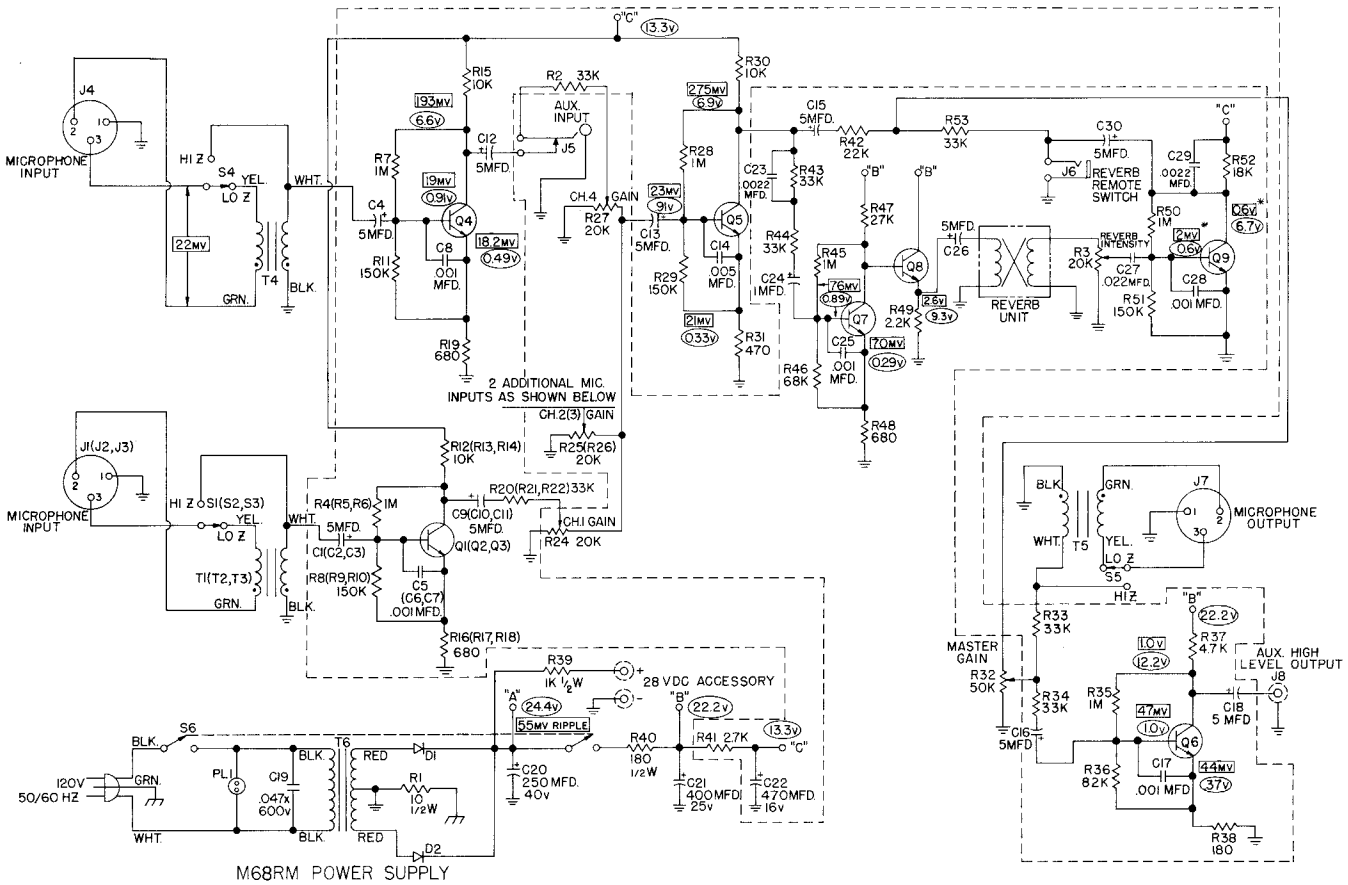

M68RM POWER SUPPLY

MODELS M68RM AND M68RM-2E ARE THE SAME EXCEPT FOR POWER SUPPLIES

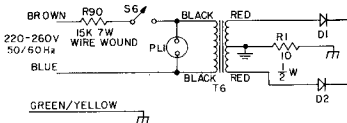

M68RM-2E POWER SUPPLY

NOTES:

1. ALL CAPACITORS IN MFD AND 100 VOLTS OR MORE UNLESS OTHERWISE SHOWN. ELECTROLYTIC CAPACITORS SHOWN IN MFD X VOLTS.
2. ALL RESISTORS 10%, 1/4 WATT UNLESS OTHERWISE SHOWN.
3. THE FOLLOWING SYMBOLS DENOTE:
 CHASSIS GROUND
 WIRING
 P.C. BOARD
 COMMON GROUND BUSES
4. DENOTES A.C. VOLTAGES
 DENOTES D.C. VOLTAGES
 ALL VOLTAGES MEASURED WITH A.C. LINE = 120 V., ALL IMPEDANCE SWITCHES SET TO LO, MIC. I AND MASTER CONTROLS MAX., ALL OTHERS MIN., MIC. I INPUT 1 KHZ SUCH THAT AUX. OUTPUT IS 1 VOLT. AUX. OUTPUT LOADED WITH 47K OHMS AND MIC. OUTPUT LOADED WITH 150 OHMS. DC. VOLTAGES MEASURED WITH 11 MEGOHM V.T.V.M. A.C. VOLTAGES MEASURED WITH 1 MEGOHM A.C. V.T.V.M. VALUES ARE TYPICAL AND MAY VARY ± 15%, REVERBERATION CONTROL FULLY COUNTERCLOCKWISE.
- *5. FOR THE MEASUREMENTS OF Q9 ONLY, DENOTED BY ASTERISKS, REVERBERATION CONTROL TO BE FULLY CLOCKWISE, AND TEST OSCILLATOR FREQUENCY ADJUSTED VERY SLIGHTLY ± 100 HZ TO OBTAIN PEAK READINGS.
6. ALL COMPONENTS AND CONNECTIONS ENCLOSED BY DASHED LINES ARE PARTS OF PRINTED CIRCUIT BOARD ASSEMBLY.
7. FOR M68RM-2E, A.C. LINE = 240 V.

MODELS M68RM AND M68RM-2E
MICROPHONE MIXERS CIRCUIT DIAGRAM

