

## SBC250 2-Up Networked Docking Station

---

### IMPORTANT SAFETY INSTRUCTIONS









1. READ these instructions.
2. KEEP these instructions.
3. HEED all warnings.
4. FOLLOW all instructions.
5. DO NOT use this apparatus near water.
6. CLEAN ONLY with dry cloth.
7. DO NOT block any ventilation openings. Allow sufficient distances for adequate ventilation and install in accordance with the manufacturer's instructions.
8. DO NOT install near any heat sources such as open flames, radiators, heat registers, stoves, or other apparatus (including amplifiers) that produce heat. Do not place any open flame sources on the product.
9. DO NOT defeat the safety purpose of the polarized or grounding type plug. A polarized plug has two blades with one wider than the other. A grounding type plug has two blades and a third grounding prong. The wider blade or the third prong are provided for your safety. If the provided plug does not fit into your outlet, consult an electrician for replacement of the obsolete outlet.
10. PROTECT the power cord from being walked on or pinched, particularly at plugs, convenience receptacles, and the point where they exit from the apparatus.
11. ONLY USE attachments/accessories specified by the manufacturer.
12. USE only with a cart, stand, tripod, bracket, or table specified by the manufacturer, or sold with the apparatus. When a cart is used, use caution when moving the cart/apparatus combination to avoid injury from tip-over.



13. UNPLUG this apparatus during lightning storms or when unused for long periods of time.
14. REFER all servicing to qualified service personnel. Servicing is required when the apparatus has been damaged in any way, such as power supply cord or plug is damaged, liquid has been spilled or objects have fallen into the apparatus, the apparatus has been exposed to rain or moisture, does not operate normally, or has been dropped.
15. DO NOT expose the apparatus to dripping and splashing. DO NOT put objects filled with liquids, such as vases, on the apparatus.
16. The MAINS plug or an appliance coupler shall remain readily operable.
17. The airborne noise of the Apparatus does not exceed 70dB (A).
18. Apparatus with CLASS I construction shall be connected to a MAINS socket outlet with a protective earthing connection.

19. To reduce the risk of fire or electric shock, do not expose this apparatus to rain or moisture.
20. Do not attempt to modify this product. Doing so could result in personal injury and/or product failure.
21. Operate this product within its specified operating temperature range.

### Explanation of Symbols

	Caution: risk of electric shock
	Caution: risk of danger (See note.)
	Direct current
	Alternating current
	On (Supply)
	Equipment protected throughout by DOUBLE INSULATION or REINFORCED INSULATION
	Stand-by
	Equipment should not be disposed of in the normal waste stream

**WARNING:** Voltages in this equipment are hazardous to life. No user-serviceable parts inside. Refer all servicing to qualified service personnel. The safety certifications do not apply when the operating voltage is changed from the factory setting.

## General Description

SBC250 networked docking station provides simple charging, configuration, and storage for either 2 ULXD6 and ULXD8 transmitters. Dock transmitters for 15 minutes to get 1 hour of use, or charge for 3 hours for a full charge.

Connect to a network to adjust transmitter settings and monitor rechargeable battery information. Use Shure control software such as Wireless Workbench® or other external control systems such as AMX or Crestron to monitor and make changes.

## Features

- Compatible with ULXD6 and ULXD8 transmitters using Shure rechargeable batteries
- Connect up to 2 transmitters for 15 minutes to get 1 hour of use, or 3 hours for a full charge
- Easily adjust transmitter settings using Shure control software such as Wireless Workbench and external control systems such as AMX or Crestron
- Monitor rechargeable battery information such as health, temperature, charge, and cycle using control software
- Update transmitter and docking station firmware using Shure Update Utility

- Rack- or wall-mountable with Shure URT3 mounting tray (sold separately)

## Rack and Wall Mounting

SBC250 can be rack- or wall-mounted using the optional Shure URT3 universal rack tray for added flexibility when storing ULXD6 boundary microphones.

①	When mounting to a rack, position the rotatable ears on the URT3 with the holes facing forward
②	For mounting to a wall, rotate the ears so the holes are flush with the surface

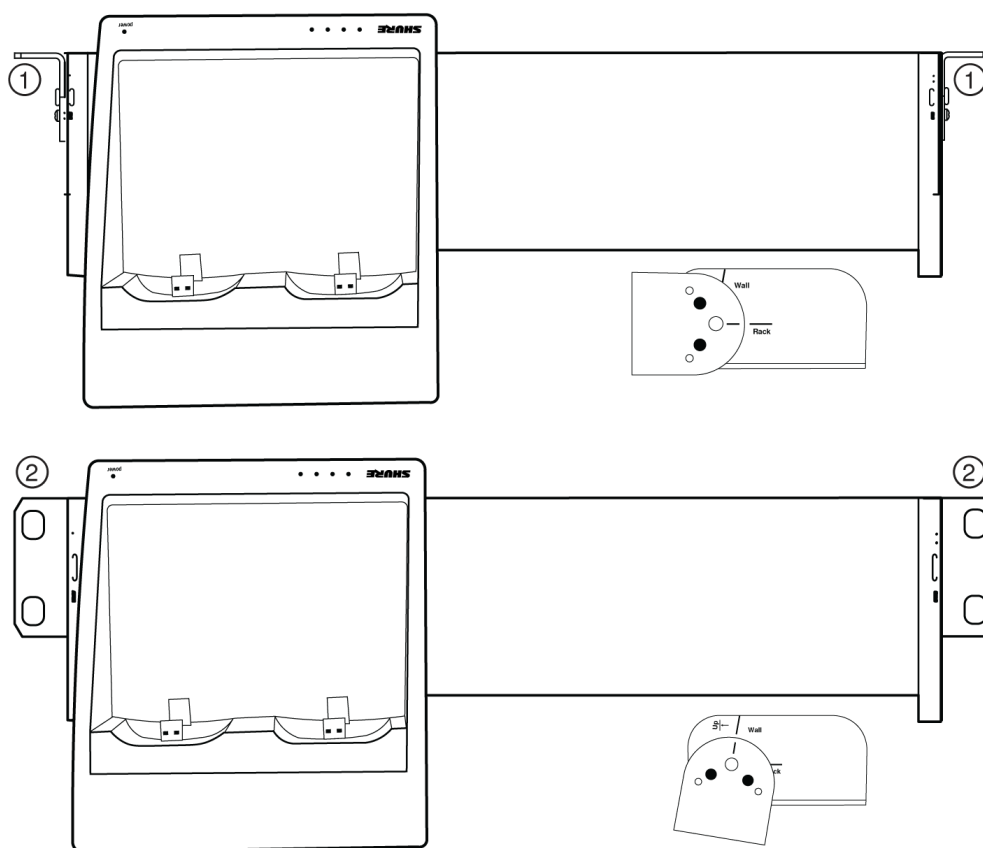

**Caution:** When mounted on the wall, insert and remove ULXD6 boundary microphones vertically to avoid damaging the USB connector

## More Information Available Online

A comprehensive online user guide is available at [pubs.shure.com](http://pubs.shure.com) (<http://pubs.shure.com>).

# Controls and Connectors

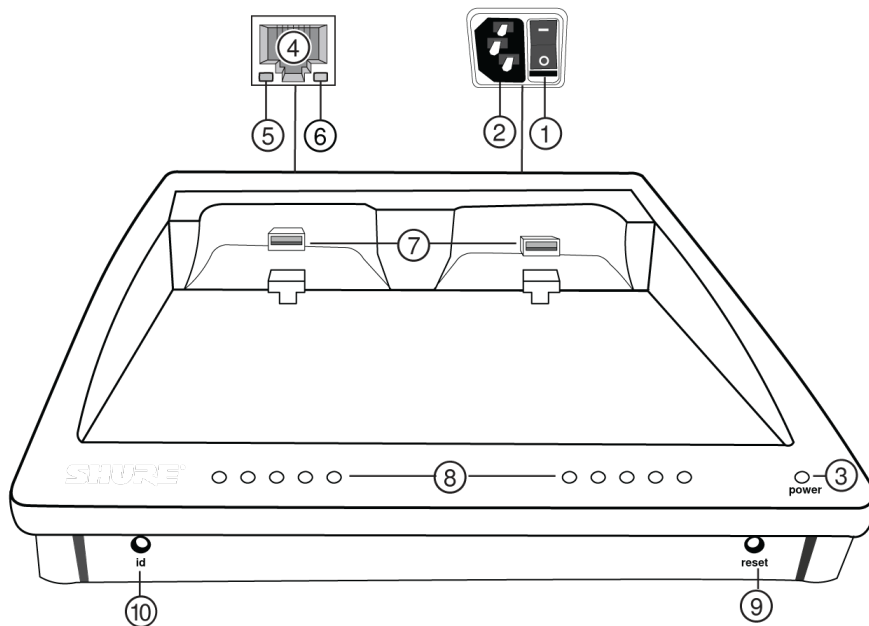

## ① Power Switch

Powers the unit on or off.

## ② AC Power

IEC connector 100 - 240 V AC.

## ③ Power LED

- On = Docking station is on
- Off = Docking station is off

## ④ Ethernet Port

Connect to an Ethernet network to enable remote device control and monitoring using Wireless Workbench or other control software.

## ⑤ Ethernet Link Speed LED (Amber)

- Off = 10 Mbps
- On = 100 Mbps

## ⑥ Ethernet Status LED (Green)

- Off = No network link
- On = Network link established
- Flashing = Network link active

## ⑦ Charging Slots (USB 3.0)

Slide any ULXD6 or ULXD8 transmitter with Shure rechargeable batteries into slots to begin charging.

## ⑧ Charging Status LEDs

Each charging slot has five LEDs that illuminate to show the battery's charge level:

LED	% Battery Charge
1	<ul style="list-style-type: none"> <li>• Flashing: &lt;10%</li> <li>• Solid: &gt;10%</li> </ul>
2	>25%
3	>50%
4	>75%
5	100%

## ⑨ Reset Button

- Docking station reset: Press and hold reset button while simultaneously powering on the docking station to restore factory settings. IP addressing will be reset to Automatic. Charging LEDs = solid green.
- Transmitter reset: Place transmitters in charging docks. Press and hold reset button for five seconds to restore transmitter factory settings. Transmitter mute LEDs = flashing.

## ⑩ ID Button

Identifies devices shown in Wireless Workbench by causing both the device's LED and the corresponding icon in WWB to flash.

---

## Power Connections

1. Connect power supply to a power outlet and to the docking station power input.
2. The docking station turns on and off via toggle switch.

If the docking station loses power, transmitters will also power off.

---

## Connecting Transmitters

Insert a ULXD6 or ULXD8 transmitter with Shure rechargeable batteries into the slot as shown:

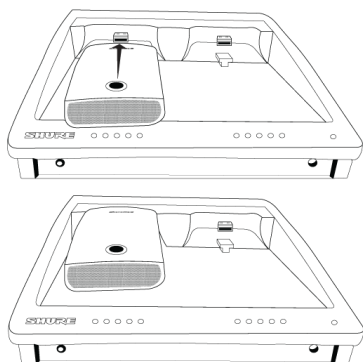

The docking station provides power to charge transmitter batteries:

- 15 minutes = 1 hour of use
- 1 hour = 50% charged
- 3 hours = 100% charged

**Note:** If the docking station loses power, transmitters will also power off. Batteries will resume charging when power is restored.

---

## Connecting Shure Devices to Wireless Workbench

Wireless Workbench lets you control and monitor devices over the network. To get started, visit <http://www.shure.com/wwb> (<http://www.shure.com/wwb>) and download Wireless Workbench software. Wireless Workbench communicates with connected devices over a standard Ethernet network.

**Required equipment:** Shure device, computer with Wireless Workbench installed, Cat 5 (or better) Ethernet cable, and router or network switch

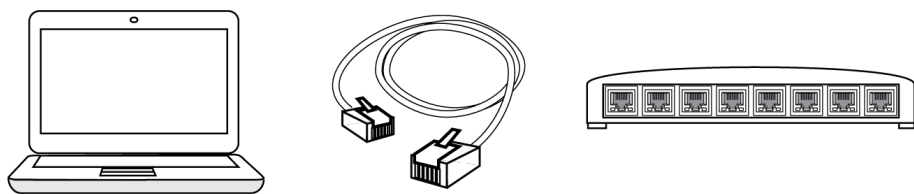

1. Connect the device to your computer with a shielded Cat 5 (or better) Ethernet cable to ensure reliable network performance. If you have multiple devices to manage, connect each device to a router or network switch. The Ethernet port LEDs on your device will illuminate to indicate network connectivity. Verify that Shure devices can see each other by looking for the network connectivity icon on the front panel (location varies).
2. For most applications, use the Automatic mode (default) to let your switch or router assign an IP address using DHCP addressing. If no DHCP server is present, your devices will fall back to a link-local address in the 169.254.xxx.xxx range. If you need to assign specific IP addresses, set the IP mode to Manual in the Network menu. Find model-specific instructions at <http://shure-community.custhelp.com/posts/a21b97f121> (<http://shure-community.custhelp.com/posts/a21b97f121>).
3. Open Wireless Workbench software.
4. Select a Network Interface in the pop-up window. Choose the network that most closely matches the Ethernet port where your devices are connected.
5. Your device will appear in the Inventory tab when the connection is successful.

## Configuration Tips

- Check your firewall settings to make sure Wireless Workbench has access to your network
- Use multiple Ethernet switches to extend the network for larger installations

For more help, visit the Help menu in Wireless Workbench or <http://www.shure.com/wwb> (<http://www.shure.com/wwb>).

## Monitoring Batteries with Wireless Workbench

Wireless Workbench provides detailed battery information for each transmitter.

Click the Inventory tab to view the networked docking station in Wireless Workbench.

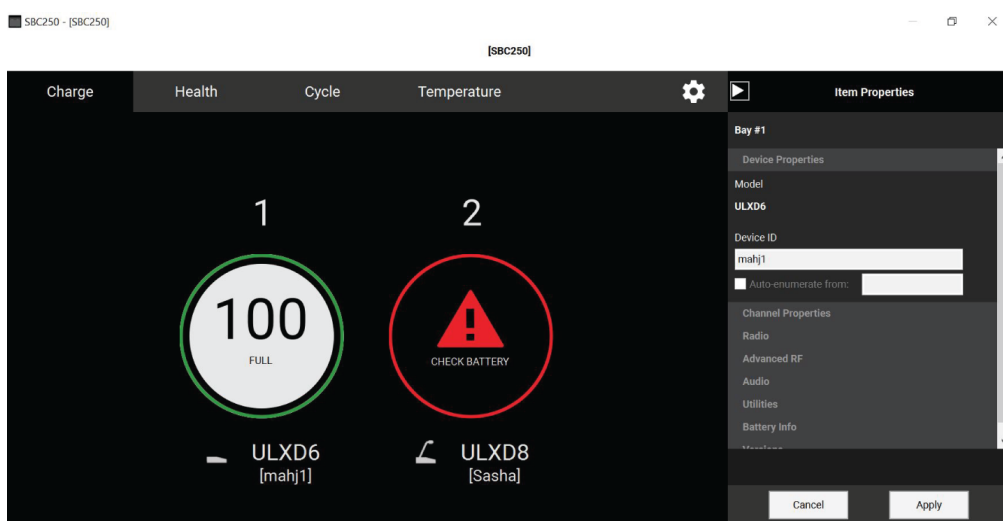

Each tab provides different battery statistics:

### Charge

Displays charge as a percentage of the total battery capacity. Also shows time remaining to full charge.

### Health

Displays health of selected battery as a percentage of the charge capacity of a new battery. Charge capacity (battery life when fully charged) will decline as a result of repeated charge cycles, age, or storage conditions.

### Cycle

Displays total number of times that the battery has undergone one full count of discharge and charge. Recharging after discharging halfway counts as one half of a cycle. Recharging after discharging a quarter of the way counts as one quarter of a cycle.

### Temperature

Displays battery temperature (in Celsius and Fahrenheit) and status.

**Tip:** To identify individual transmitters on the SBC250, press and hold the mute button on your ULXD6 or ULXD8 to make the corresponding icon in WWB flash. Clicking Dismiss all clears the flashing.

---

## Controlling Transmitters with Networked Docking Stations

Quickly review and control many transmitter settings using Wireless Workbench or other external control systems.

You can adjust the following settings:

- Mute button and mute LED behavior or brightness
- High-pass filter
- RF power
- Power lock
- Initial state from charger
- Battery type
- Device name
- Channel name
- Frequency
- Normal or High-Density Mode
- Boundary and gooseneck offset

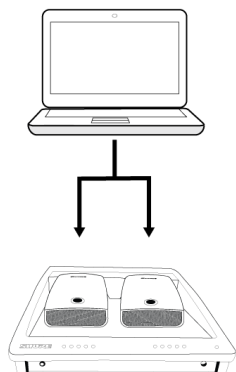

1. Place transmitters on the docking station. Check that the docking station is connected to the network and to Wireless Workbench.
2. Find the docking station in the inventory and right-click to select Properties.
3. Select one or multiple transmitters.
4. Make changes to transmitter settings and select Apply. Transmitters are now ready to use.

---

## Connecting to an External Control System

SBC250 networked docking stations connect to external control systems such as AMX or Crestron via the Ethernet. Use only one controller per system to avoid messaging conflicts. For a comprehensive list of command strings, visit <http://www.shure.com> (<http://www.shure.com>).

- Connection: Ethernet (TCP/IP; SBC250 is the client)
- Port: 2202



## Firmware Updates

Firmware is embedded software in each component that controls functionality. Periodically, new versions of firmware are developed to incorporate additional features and enhancements. To take advantage of design improvements, download new versions of the firmware using the Shure Update Utility tool.

Download Shure Update Utility at <http://www.shure.com/suu> (<http://www.shure.com/suu>).

## Updating Transmitter Firmware with Docking Station

1. Place transmitters on the docking station and check that docking station is connected to the network.
2. Launch Shure Update Utility to find firmware updates.
3. Download updates and click Send Updates.

## Model Variations

All include power supply unless otherwise noted.

Region	Model
United States	SBC250-US
Argentina	SBC250-AR
Brazil	SBC250-BR
Europe	SBC250-E
United Kingdom	SBC250-UK
Japan	SBC250-J
China	SBC250-CN
Korea	SBC250-K
Taiwan	SBC250-TW
Australia	SBC250-AZ
India	SBC250-IN
Global	SBC250 (no power supply)

---

# Specifications

## SBC250

### Charge Time

ULXD6 and ULXD8	15 minutes = 1 hour runtime; 1 hour = 50% charged; 3 hours = 100% charged
-----------------	---

### Network Interface

10/100 Mbps Ethernet

### Power Requirement

100 - 240V AC @ 0.35 A maximum, 50/60 Hz

### Housing

Molded Plastic, Sheet Metal

### Dimensions

215 x 191 x 62.5 mm (8.46 x 7.52 x 2.44in.)

### Weight

2.7 kg(5.95 lb)

### Operating Temperature Range

0°C (32°F) to 45°C (113°F)

### Storage Temperature Range

-29°C (-20°F) to 74°C (165°F)

---

## Certifications

Meets essential requirements of all applicable European Directives.

The CE Declaration of Conformity can be obtained from: [www.shure.com/europe/compliance](http://www.shure.com/europe/compliance)

Authorized European representative:

Shure Europe GmbH

Headquarters Europe, Middle East & Africa

Department: EMEA Approval

Jakob-Dieffenbacher-Str. 12

75031 Eppingen, Germany

Phone: +49-7262-92 49 0

Fax: +49-7262-92 49 11 4

Email: info@shure.de

Operation of this device is subject to the following two conditions: (1) this device may not cause interference, and (2) this device must accept any interference, including interference that may cause undesired operation of the device.

Le présent appareil est conforme aux CNR d'Industrie Canada applicables aux appareils radio exempts de licence. L'exploitation est autorisée aux deux conditions suivantes : (1) l'appareil ne doit pas produire de brouillage, et (2) l'utilisateur de l'appareil doit accepter tout brouillage radioélectrique subi, même si le brouillage est susceptible d'en compromettre le fonctionnement.

Eligible for CE marking.

Authorized under the verification provision of FCC Part 15B.

CAN ICES-3 (B)/NMB-3 (B)

**Industry Canada ICES-003 Compliance Label:** CAN ICES-3 (B)/NMB-3(B)

**Note:** See the label located on the bottom side of the charger enclosure for the FCC marking, the CE marking, the RCM marking, the KC marking, and the electrical ratings.

**Note:** EMC conformance testing is based on the use of supplied and recommended cable types. The use of other cable types may degrade EMC performance.

Changes or modifications not expressly approved by Shure Incorporated could void your authority to operate this equipment.

Meets requirements of the following standards:

EN55032

EN55103-2

EN55024

EN60950

Korea KN32/35

IEC60950

Please consider the environment, electric products and packaging are part of regional recycling schemes and do not belong to regular household waste.

---

## Important Product Information

**WARNING:** Danger of explosion if incorrect battery replaced. Operate only with AA batteries.

### WARNING

- Battery packs may explode or release toxic materials. Risk of fire or burns. Do not open, crush, modify, disassemble, heat above 140°F (60°C), or incinerate.
- Follow instructions from manufacturer
- Only use Shure charger to recharge Shure rechargeable batteries
- **WARNING:** Danger of explosion if battery incorrectly replaced. Replace only with same or equivalent type.

- Never put batteries in mouth. If swallowed, contact your physician or local poison control center
- Do not short circuit; may cause burns or catch fire
- Do not charge or use battery packs other than Shure rechargeable batteries
- Dispose of battery packs properly. Check with local vendor for proper disposal of used battery packs.
- Batteries (battery pack or batteries installed) shall not be exposed to excessive heat such as sunshine, fire or the like

---

## Information to the user

This equipment has been tested and found to comply with the limits for a Class B digital device, pursuant to Part 15 of the FCC Rules. These limits are designed to provide reasonable protection against harmful interference in a residential installation. This equipment generates uses and can radiate radio frequency energy and, if not installed and used in accordance with the instructions, may cause harmful interference to radio communications. However, there is no guarantee that interference will not occur in a particular installation. If this equipment does cause harmful interference to radio or television reception, which can be determined by turning the equipment off and on, the user is encouraged to try to correct the interference by one or more of the following measures:

- Reorient or relocate the receiving antenna.
- Increase the separation between the equipment and the receiver.
- Connect the equipment to an outlet on a circuit different from that to which the receiver is connected.
- Consult the dealer or an experienced radio/TV technician for help.

## LICENSING INFORMATION

Licensing: A ministerial license to operate this equipment may be required in certain areas. Consult your national authority for possible requirements. Changes or modifications not expressly approved by Shure Incorporated could void your authority to operate the equipment. Licensing of Shure wireless microphone equipment is the user's responsibility, and licensability depends on the user's classification and application, and on the selected frequency. Shure strongly urges the user to contact the appropriate telecommunications authority concerning proper licensing, and before choosing and ordering frequencies.

Please follow your regional recycling scheme for batteries, packaging, and electronic waste.