

SBC840M -- 8-Bay Networked Charger

IMPORTANT SAFETY INSTRUCTIONS









1. READ these instructions.
2. KEEP these instructions.
3. HEED all warnings.
4. FOLLOW all instructions.
5. DO NOT use this apparatus near water.
6. CLEAN ONLY with dry cloth.
7. DO NOT block any ventilation openings. Allow sufficient distances for adequate ventilation and install in accordance with the manufacturer's instructions.
8. DO NOT install near any heat sources such as open flames, radiators, heat registers, stoves, or other apparatus (including amplifiers) that produce heat. Do not place any open flame sources on the product.
9. DO NOT defeat the safety purpose of the polarized or grounding type plug. A polarized plug has two blades with one wider than the other. A grounding type plug has two blades and a third grounding prong. The wider blade or the third prong are provided for your safety. If the provided plug does not fit into your outlet, consult an electrician for replacement of the obsolete outlet.
10. PROTECT the power cord from being walked on or pinched, particularly at plugs, convenience receptacles, and the point where they exit from the apparatus.
11. ONLY USE attachments/accessories specified by the manufacturer.
12. USE only with a cart, stand, tripod, bracket, or table specified by the manufacturer, or sold with the apparatus. When a cart is used, use caution when moving the cart/apparatus combination to avoid injury from tip-over.



13. UNPLUG this apparatus during lightning storms or when unused for long periods of time.
14. REFER all servicing to qualified service personnel. Servicing is required when the apparatus has been damaged in any way, such as power supply cord or plug is damaged, liquid has been spilled or objects have fallen into the apparatus, the apparatus has been exposed to rain or moisture, does not operate normally, or has been dropped.
15. DO NOT expose the apparatus to dripping and splashing. DO NOT put objects filled with liquids, such as vases, on the apparatus.
16. The MAINS plug or an appliance coupler shall remain readily operable.
17. The airborne noise of the Apparatus does not exceed 70dB (A).
18. Apparatus with CLASS I construction shall be connected to a MAINS socket outlet with a protective earthing connection.
19. To reduce the risk of fire or electric shock, do not expose this apparatus to rain or moisture.
20. Do not attempt to modify this product. Doing so could result in personal injury and/or product failure.

21. Operate this product within its specified operating temperature range.

Explanation of Symbols

	Caution: risk of electric shock
	Caution: risk of danger (See note.)
	Direct current
	Alternating current
	On (Supply)
	Equipment protected throughout by DOUBLE INSULATION or REINFORCED INSULATION
	Stand-by
	Equipment should not be disposed of in the normal waste stream

WARNING: Voltages in this equipment are hazardous to life. No user-serviceable parts inside. Refer all servicing to qualified service personnel. The safety certifications do not apply when the operating voltage is changed from the factory setting.

WARNING

- Battery packs may explode or release toxic materials. Risk of fire or burns. Do not open, crush, modify, disassemble, heat above 140°F (60°C), or incinerate.
- Follow instructions from manufacturer
- Only use Shure charger to recharge Shure rechargeable batteries
- **WARNING:** Danger of explosion if battery incorrectly replaced. Replace only with same or equivalent type.
- Never put batteries in mouth. If swallowed, contact your physician or local poison control center
- Do not short circuit; may cause burns or catch fire
- Do not charge or use battery packs other than Shure rechargeable batteries
- Dispose of battery packs properly. Check with local vendor for proper disposal of used battery packs.
- Batteries (battery pack or batteries installed) shall not be exposed to excessive heat such as sunshine, fire or the like

Caution: Do not transport chargers with batteries inserted.

Warning: Do not charge batteries in enclosed spaces without proper ventilation.

WARNING: This product contains a chemical known to the State of California to cause cancer and birth defects or other reproductive harm.

Please follow your regional recycling scheme for batteries, packaging, and electronic waste.

Note: Model information and power ratings are labeled on the bottom of the unit.

General Description

The SBC840M networked charger provides a compact charging and storage solution for up to 8 SB910M batteries. The charger is network-enabled to allow for remote monitoring of charger and battery parameters using Shure Wireless Workbench® software.

Features

- Charging for up to 8 SB910M batteries
- LEDs indicate charge status and errors
- Storage mode to prepare batteries for long-term storage
- Network-enabled for remote monitoring

Furnished Accessories

Power supply	PS60
--------------	------

Note: Model availability depends on region. See your local Shure dealer or distributor for details.

Controls and Connectors

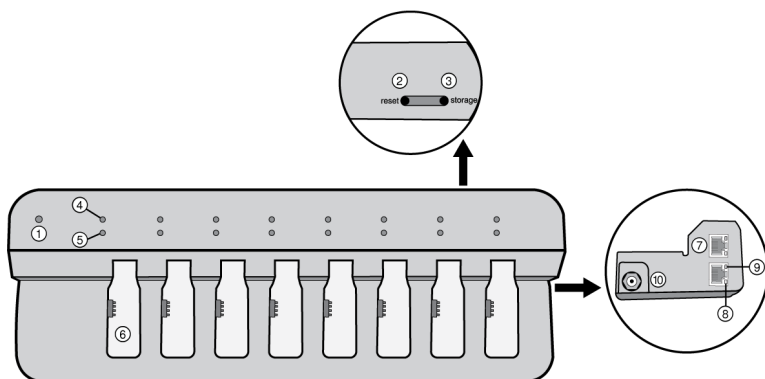

① Power LED

- White = Power is on
- Red = Charger is in storage mode

② Reset Button

Press and hold to restore charger factory settings, including network settings.

③ Storage Mode Button

Press and hold to activate or deactivate storage mode, which charges or discharges batteries to the optimal voltage for long-term storage.

④ Charging Status LED

- Red = Charging
- Green = Charging complete
- Amber = Battery is in storage mode

See LED Indicators for details.

⑤ Error LED

Flashes amber to indicate a problem charging batteries. Errors are also displayed in Wireless Workbench. See LED Indicators for details.

⑥ Charging Slots

Insert 1 SB910M battery.

⑦ Ethernet Port

Connect to a network to remotely monitor batteries and control charger settings using Wireless Workbench.

⑧ Ethernet Link Speed LED (Amber)

- Off = 10 Mbps
- On = 100 Mbps

⑨ Ethernet Status LED (Green)

- Off = No network link
- On = Network link established
- Flashing = Network link active

⑩ Power Input

Connect to power supply.

Power

1. Connect DC power cable to input jack. Finger tighten lock nut for a secure connection.
2. Connect power supply to AC power outlet.

WARNING:

- Do not use pliers or any other tools to tighten lock nut. DC power cable must be attached before charger unit is installed.
- Do not plug in power supply unit until DC connection and charger are in place.
- After securing the charger, plug the power cable into a properly grounded outlet.

The charger has no power switch. When plugged in, the power LED illuminates. The charging LEDs illuminate after batteries are inserted.

Charging

To charge, place batteries into the charging bays with the battery contacts facing down. The LEDs illuminate to indicate battery status.

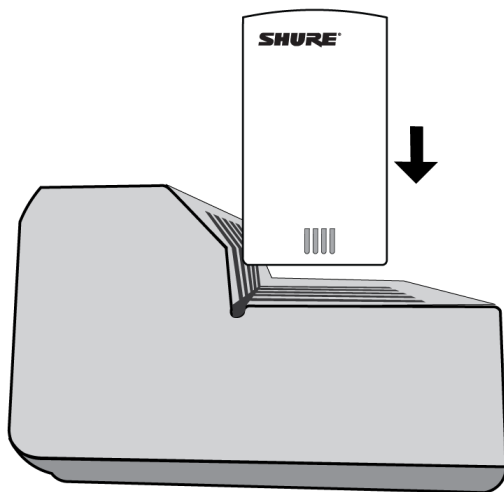

LED Indicators

Color	State
Charge status LED red	Charging
Charge status LED green	Charging complete
Error LED amber flashing	Charging stopped. To resume charging, try these solutions: <ol style="list-style-type: none"> 1. Check that the battery contacts are clean and undamaged. If contacts are dirty or damaged, the charger might not detect the batteries. 2. Check the temperature. If the battery temperature is above 60°C or below 0°C, the error LED flashes. 3. Contact Shure service. Battery may be discharged beyond recovery or have internal problems. Replace battery.
<ul style="list-style-type: none"> • Charge status LED red • Error LED amber flashing 	Battery too warm. Charging stops at 80% of full capacity. Allow battery to cool below 45°C to resume charging to full capacity.
<ul style="list-style-type: none"> • Charge status LED green • Error LED amber flashing 	Charging complete, but battery temperature is too warm or cold (over 60°C or below 0°C).
Power LED red	Charger is in storage mode. Batteries are charging or discharging to storage voltage.

Color	State
<ul style="list-style-type: none"> • Power LED red • Charge status LED amber 	Batteries are ready for storage.
<ul style="list-style-type: none"> • Power LED red • Charge status LED red flashing 	Batteries are approaching storage voltage.
Power LED white flashing	Charger firmware is being updated.
All LEDs flashing	Hardware identification.

Tip: Wireless Workbench provides more detailed battery status information.

Storage Mode

To store batteries for longer than 8 days, use the charger's storage mode. Each battery will be charged or discharged to 3.8 volts, which is ideal for long-term storage.

To enter storage mode, press and hold storage for 3 seconds until the power LED turns red. The batteries will begin charging or discharging to 3.8 volts, which may take several hours. The LEDs indicate when the battery is approaching storage voltage or at storage voltage.

To exit storage mode, press and hold storage. The power LED changes to white and batteries resume charging normally.

When batteries are ready for storage, remove them from the charger and place in a temperature-controlled area. Recommended battery storage temperature is 10°C (50°F) to 25°C (77°F).

Note: Run storage mode once every 6 months to maintain the storage voltage.

Restoring Factory Settings

Press and hold reset to restore factory settings. All LEDs will flash and turn off as the charger reboots.

IP addressing will be set to automatic, and charger will be in charging mode.

Network Connections

Use Ethernet cables to connect chargers to a network to monitor charging, battery health, and other parameters.

For most installations, use a star network topology with an Ethernet switch. For smaller installations, you can connect chargers to each other in a series.

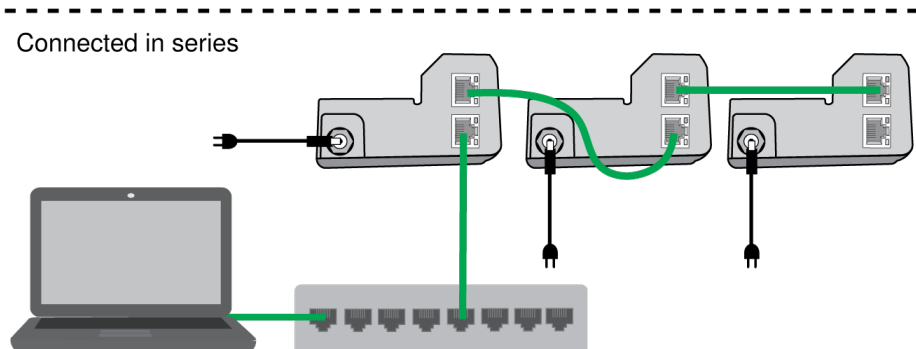
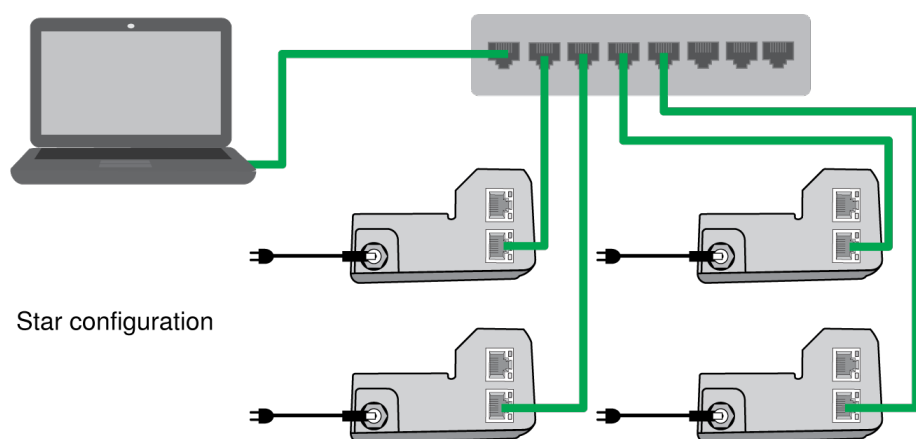

Tip: Use a star network topology to update charger firmware. If chargers are connected to each other in a series, firmware updates may cause network connection problems.

Connecting Shure Devices to Wireless Workbench

Wireless Workbench lets you control and monitor devices over the network. To get started, visit <http://www.shure.com/wwb> (<http://www.shure.com/wwb>) and download Wireless Workbench software. Wireless Workbench communicates with connected devices over a standard Ethernet network.

Required equipment: Shure device, computer with Wireless Workbench installed, Cat 5 (or better) Ethernet cable, and router or network switch

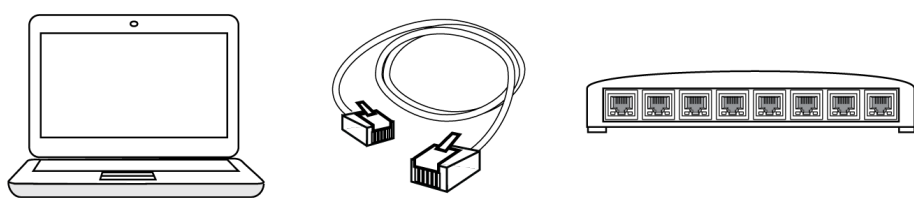

1. Connect the device to your computer with a shielded Cat 5 (or better) Ethernet cable to ensure reliable network performance. If you have multiple devices to manage, connect each device to a router or network switch. The Ethernet port LEDs on your device will illuminate to indicate network connectivity. Verify that Shure devices can see each other by looking for the network connectivity icon on the front panel (location varies).
2. For most applications, use the Automatic mode (default) to let your switch or router assign an IP address using DHCP addressing. If no DHCP server is present, your devices will fall back to a link-local address in the 169.254.xxx.xxx range. If you need to assign specific IP addresses, set the IP mode to Manual in the Network

menu. Find model-specific instructions at <http://shure-community.custhelp.com/posts/a21b97f121> (<http://shure-community.custhelp.com/posts/a21b97f121>).

3. Open Wireless Workbench software.
4. Select a Network Interface in the pop-up window. Choose the network that most closely matches the Ethernet port where your devices are connected.
5. Your device will appear in the Inventory tab when the connection is successful.

Configuration Tips

- Check your firewall settings to make sure Wireless Workbench has access to your network
- Use multiple Ethernet switches to extend the network for larger installations

For more help, visit the Help menu in Wireless Workbench or <http://www.shure.com/wwb> (<http://www.shure.com/wwb>).

Monitoring Batteries with Wireless Workbench

Wireless Workbench provides detailed information for batteries currently docked in the charger. You can also view battery error notifications and change the charger's network settings.

Click the Inventory tab to view your charger in Wireless Workbench. The charger properties panel provides different battery statistics:

Charge

Displays charge as a percentage of the total battery capacity. Also shows time remaining to full charge.

Health

Displays health of selected battery as a percentage of the charge capacity of a new battery. Charge capacity (battery life when fully charged) will decline as a result of repeated charge cycles, age, or storage conditions.

Cycle

Displays total number of times that the battery has undergone one full count of discharge and charge. Recharging after discharging halfway counts as one half of a cycle. Recharging after discharging a quarter of the way counts as one quarter of a cycle.

Temperature

Displays battery temperature (in Celsius and Fahrenheit) and status.

Charger Network Settings

To adjust charger network settings, open the charger properties panel in Wireless Workbench. Click the gear icon to set the IP mode and IP address, view the MAC address, and view firmware version.



Firmware

Firmware is embedded software in each component that controls functionality. Periodically, new versions of firmware are developed to incorporate additional features and enhancements. To take advantage of design improvements, new versions of the firmware can be downloaded and installed using the Shure Update Utility tool.

Software is available for download from <http://www.shure.com/update-utility>.

Connecting to an External Control System

The SBC840M networked charging station connects to external control systems such as AMX or Crestron via the Ethernet. For a comprehensive list of command strings, visit pubs.shure.com/guide/SBC840M (<http://pubs.shure.com/guide/SBC840M>).

- Connection: Ethernet (TCP/IP; SBC840M is the client)
 - Port: 2202
-

Power Save Mode

Use power save mode to charge batteries with the charger's network functionality off.

1. Disconnect the power cable from the AC power outlet.
2. Press and hold storage while reconnecting to the AC power outlet.
3. When the charge status and error LEDs flash amber, release the button.

Note: The charger will power off 30 minutes after it finishes charging batteries. Press reset or storage to turn it on.

Vertical Mounting

Three mounting points on the bottom of the charger fit #6 round or pan head screws. Mount to a hard surface using 3 screws that are long enough to secure the charger. To mount, orient the charger so that the 2 mounting points are on top as shown.

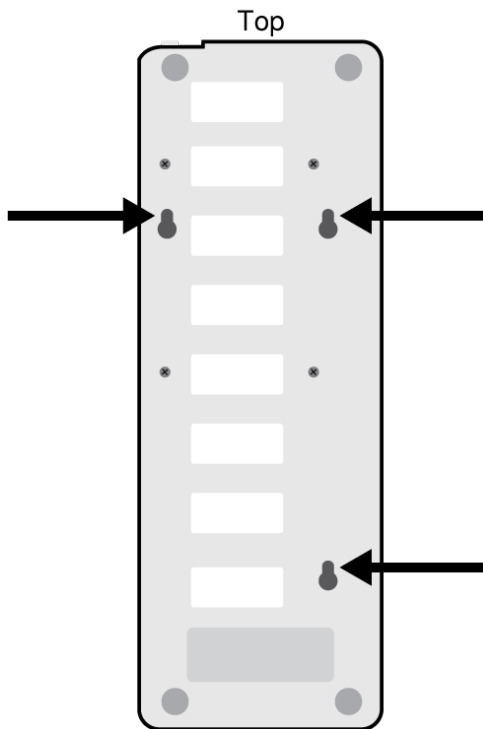

Specifications

SBC840M

Battery Type

Up to 8 SB910M

Charge Current

575 mA maximum

Charge Time

1 hour = 50% charged; 3 hours = 100% charged

External Power Supply

PS60

Power Requirement

15 V, 3.33 A maximum

Housing

Molded Plastic

Dimensions

52.06 x 88.22 x 250.54 mm (2.05 x 3.47 x 9.86 in.) H x W x D

Weight

425 g (1 lb) Without Battery

Operating Temperature Range

-18°C (0°F) to 50°C (122°F)

Note: Battery characteristics may limit this range.

Storage Temperature Range

-29°C (-20°F) to 74°C (165°F)

Note: Battery characteristics may limit this range.

Network Interface

10/100 Mbps Ethernet

Network Addressing Capability

DHCP or Manual IP address

Certifications

Meets essential requirements of all applicable European Directives.

Eligible for CE marking.

The CE Declaration of Conformity can be obtained from: www.shure.com/europe/compliance

Authorized European representative:

Shure Europe GmbH

Headquarters Europe, Middle East & Africa

Department: EMEA Approval

Jakob-Dieffenbacher-Str. 12

75031 Eppingen, Germany

Phone: +49-7262-92 49 0

Fax: +49-7262-92 49 11 4

Email: info@shure.de

Operation of this device is subject to the following two conditions: (1) this device may not cause interference, and (2) this device must accept any interference, including interference that may cause undesired operation of the device.

Le présent appareil est conforme aux CNR d'Industrie Canada applicables aux appareils radio exempts de licence. L'exploitation est autorisée aux deux conditions suivantes : (1) l'appareil ne doit pas produire de brouillage, et (2) l'utilisateur de l'appareil doit accepter tout brouillage radioélectrique subi, même si le brouillage est susceptible d'en compromettre le fonctionnement.

Authorized under the verification provision of FCC Part 15B.

CAN ICES-3 (B)/NMB-3 (B)

Information to the user

This equipment has been tested and found to comply with the limits for a Class B digital device, pursuant to Part 15 of the FCC Rules. These limits are designed to provide reasonable protection against harmful interference in a residential installation. This equipment generates uses and can radiate radio frequency energy and, if not installed and used in accordance with the instructions, may cause harmful interference to radio communications. However, there is no guarantee that interference will not occur in a particular installation. If this equipment does cause harmful interference to radio or television reception, which can be determined by turning the equipment off and on, the user is encouraged to try to correct the interference by one or more of the following measures:

- Reorient or relocate the receiving antenna.
- Increase the separation between the equipment and the receiver.
- Connect the equipment to an outlet on a circuit different from that to which the receiver is connected.
- Consult the dealer or an experienced radio/TV technician for help.

Note: EMC conformance testing is based on the use of supplied and recommended cable types. The use of other cable types may degrade EMC performance.

Changes or modifications not expressly approved by Shure Incorporated could void your authority to operate this equipment.

Please consider the environment, electric products and packaging are part of regional recycling schemes and do not belong to regular household waste.

臺灣進口商資訊：益誠國際驗證股份有限公司/臺北市中山區長安東路2段108號7樓之5

設備名稱：連網充電器，型號（型式）：SBC840M Equipment name Type designation (Type)						
單元 Unit	限用物質及其化學符號 (Restricted substances and its chemical symbol)					
	鉛 Lead (Pb)	汞 Mercury (Hg)	鎘 Cadmium (Cd)	六价铬 Hexavalent chromium (Cr ⁶⁺)	多溴联苯 Polybrominated biphenyls (PBB)	多溴二苯醚 Polybrominated diphenyl ethers (PBDE)
电路板	○	○	○	○	○	○
線束	○	○	○	○	○	○
外殼	○	○	○	○	○	○
電子零件	○	○	○	○	○	○
電源供應器	-	○	○	○	○	○
備考1. “超出0.1 wt %”及“超出0.01 wt %”係指限用物質之百分比含量超出百分比含量基準值。 “Exceeding 0.1 wt %” and “exceeding 0.01 wt %” indicate that the percentage content of the restricted substance exceeds the reference percentage value of presence condition. 備考2. “○”：係指該項限用物質之百分比含量未超出百分比含量基準值。 “○” indicates that the percentage content of the restricted substance does not exceed the percentage of reference value of presence. 備考3. “-”：係指該項限用物質為排除項目。 The “-” indicates that the restricted substance corresponds to the exemption.						