

GENERAL

The Shure Model SM80 is a high-quality, omnidirectional condenser microphone designed for the most demanding professional applications in studio recording, broadcasting and sound reinforcement. It is especially suitable for applications requiring extremely wide frequency response, low noise and distortion characteristics, very low RF susceptibility, and reliable operation over a wide range of temperature and humidity extremes. The SM80 features a selectable 10 dB attenuator and a three-position low-frequency response switch. The case is constructed of steel for ruggedness, with a stainless steel screen, and finished in durable vinyl paint.

The SM80 is designed for phantom (simplex) powering from an external supply such as the Shure Model PS1A, or directly from recording, broadcast or sound reinforcement equipment. The SM80 operates over a wide voltage range covering both DIN Standard 45 596 phantom voltages of 12 and 48 volts.

The microphone is supplied with a highly efficient pop filter grille (Model A81G), attenuator lock, and swivel adapter. Also available for use with the SM80 are a unidirectional microphone cartridge (Model R104), a heavy-duty windscreen (Model A81WS), and a compact, lightweight microphone stand (Model S15) capable of being extended to 4.3m (14 ft). A dual-channel power supply (Model PS1A) is available for providing phantom power to the SM80.

Model SM80 Features:

- Wide-range frequency response for exceptionally accurate recording and sound reinforcement applications
- Low noise and high output clipping level characteristics
- Low distortion characteristics over the entire audio spectrum for a wide range of load impedances
- Omnidirectional polar pattern is equally sensitive to sounds from all directions
- Very low RF susceptibility
- Selectable low-frequency response: flat, 6 or 18 dB/octave rolloff
- 10 dB attenuator accessible without disassembly; lockable in either position
- Wide-range phantom powering includes DIN 45 596 voltages of 12 and 48 Vdc
- Rugged construction for outstanding reliability
- Field-usable over wide range of temperature and humidity conditions

VARIATIONS

Model SM80-LC: Supplied less cable.



SPECIFICATIONS

- Type**
Omnidirectional condenser (electret bias)
- Frequency Response**
20 to 20,000 Hz (see Figure 1)

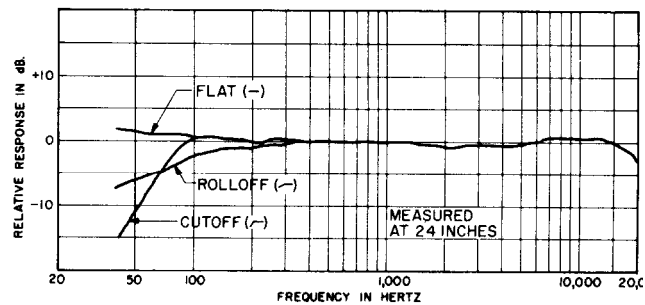

TYPICAL FREQUENCY RESPONSE
FIGURE 1

- Polar Pattern**
Omnidirectional (see Figure 2)

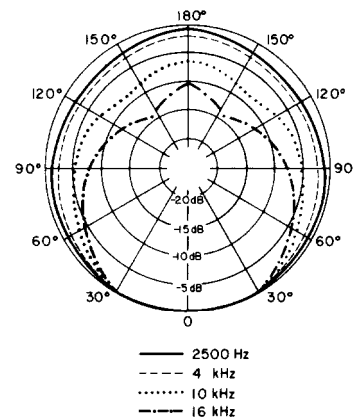

TYPICAL POLAR PATTERNS
FIGURE 2

Output Impedance

Rated at 150 ohms (85 ohms actual)
Recommended minimum load impedance: 800 ohms
(May be used with loads as low as 150 ohms with reduced clipping level)

Output Level (at 1,000 Hz)

Open Circuit Voltage -65 dB (0.56 mV)
(0 dB = 1 volt per microbar)
Equivalent Power Level -40.5 dB
(0 dB = 1 milliwatt with 10 microbars)

Clipping Level (at 1,000 Hz)

800-ohm Load - 4 dBV (0.63V)
150-ohm Load - 15 dBV (0.18V)

Total Harmonic Distortion

Less than 0.5% (132 dB SPL at 250 Hz into 800-ohm load)

Maximum SPL (at 1,000 Hz)

137 dB (attenuator at 0); 147 dB (attenuator at 10)
with 800-ohm load
129 dB (attenuator at 0); 139 dB (attenuator at 10)
with 150-ohm load

Hum Pickup

-4 dB equivalent SPL in a 1 millioersted field (60 Hz)

Output Noise (equivalent sound pressure levels)

17 dB typical, A-weighted
20 dB typical, weighted per DIN 45 405

Signal-to-Noise Ratio

77 dB (IEC 179)* at 94 dB SPL

Overvoltage and Reverse Polarity Protection

Max. External Voltage Applied to
Pins 2 and 3 with Respect to Pin 1 + 52 Vdc
Reverse Polarity Protection 200 mA max.
(diode-clamped)

Phasing

Positive pressure on diaphragm produces positive voltage on pin 2 relative to pin 3

Cartridge Capacitance

31 pF

LF Response Switch

Flat, -6 dB/octave below 100 Hz, -18 dB/octave below 80 Hz

Attenuator Switch

0 or 10 dB (68 pF)

Power

Supply Voltage 11 to 52 Vdc, positive pins 2 and 3
Current Drain 1.0 mA to 1.2 mA

Environmental Conditions

Relative Humidity 0 - 50% -29° to 74°C
(-20° to 165°F)
Relative Humidity 0 - 95% -29° to 57°C
(-20° to 135°F)

Connector

Professional three-pin audio**

Case

Steel construction with metallic vinyl paint finish and stainless steel screen

Dimensions

See Figure 3

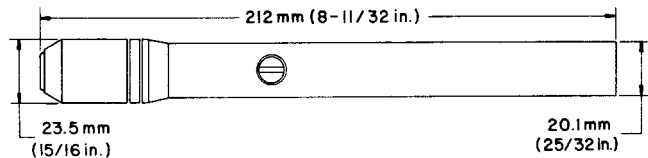

OVERALL DIMENSIONS
FIGURE 3

Weight

Net 230 grams (8 oz)
Packaged 1.2 kg (2 lb 10 oz)

*S/N ratio is difference between microphone output at 94 dB SPL and microphone self-noise A-weighted.

**Designed to mate with Cannon XL series, Witchcraft A3 (Q.G.) series or equivalent connectors.

OPERATION

The SM80 is designed for phantom powering by a Shure Model PS1A Power Supply, or by virtually any microphone power supply providing 12 to 48 Vdc phantom voltage.

Use only high-quality cables, as intermittent shorts between broken shield wires and balanced conductors will cause extremely large noise transients in the system. Avoid ground loops due to grounded connector shells or the microphone case touching other grounded metal objects. Follow generally accepted audio grounding practices.

Paralleling or "Y-ing" the SM80 with another microphone (two microphones on the same input) is not recommended; separate inputs are preferable. However, paralleling two SM80's may be accomplished with either a reduction in maximum SPL and output level, or a reduction only in output level if the microphones are electrically isolated. With the microphones paralleled either before or after a PS1A Power Supply, the maximum SPL is reduced by approximately 10 dB and the output level by 6 dB. The reduction in maximum SPL can be avoided by using either two Shure A15AS Attenuators and a Switchcraft 391Q43 Y-Adapter to isolate the microphones, or an isolation network as shown in Figure 4. The network reduces each microphone output level by 8 dB, while the A15AS reduces the output level by 5 dB plus the attenuator's 15, 20 or 25 dB (switch-selectable). The network or attenuators can be inserted between the power supply outputs and mixer input, or between two microphones and a single power supply input. Note that a PS1A Power Supply can power two SM80's on each input; other power supplies should be checked to see if they can supply a minimum of 10 Vdc at each microphone when both microphones are connected.

A minimum load impedance of 800 ohms or greater should be used for maximum signal handling and minimum distortion. The load may be as low as 150

ohms, but a reduction in output clipping level will result. It should be noted that the power supply itself may add loading (3300 ohms in the Shure PS1A Power Supply) to the microphones.

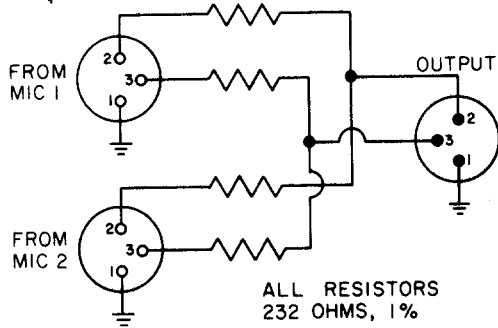

ISOLATION NETWORK
FIGURE 4

PS1A POWER SUPPLY

Connect the microphone cable to the SM80 and the power supply MICROPHONE connector. The power supply uses the balanced audio cable pair to carry the supply current to the microphone, and the cable shield as a ground return.

Connect the power supply OUTPUT connector to a low-impedance microphone input of the mixer, audio console or tape recorder. A second SM80 may be connected to the remaining power supply channel in a similar manner.

ALTERNATE POWER SOURCES

As an alternate to the PS1A power supply, the SM80 may be phantom-powered from virtually any mixer, audio console or tape recorder using one of the wiring configurations shown in Figures 5 and 6. Any well-filtered voltage available in the mixer from 12 to 48 Vdc may be used. The graph in Figure 7 shows the range of values which can be used for resistor R when the SM80 is used with a regulated power supply. The tolerance of the resistors (2R) shown in Figure 5 should be 1% or

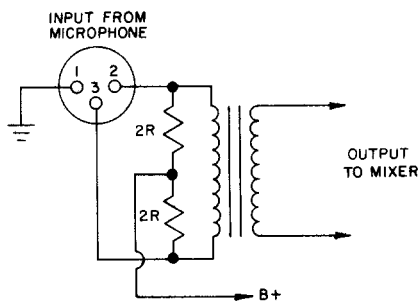

TWO-RESISTOR CONFIGURATION
FIGURE 5

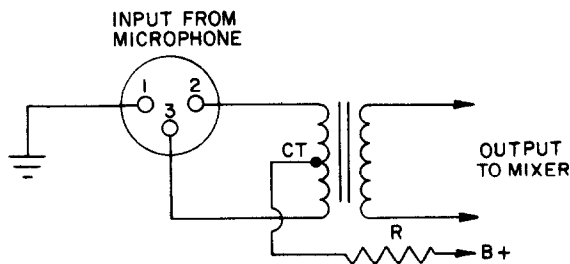

CENTER-TAPPED TRANSFORMER
CONFIGURATION
FIGURE 6

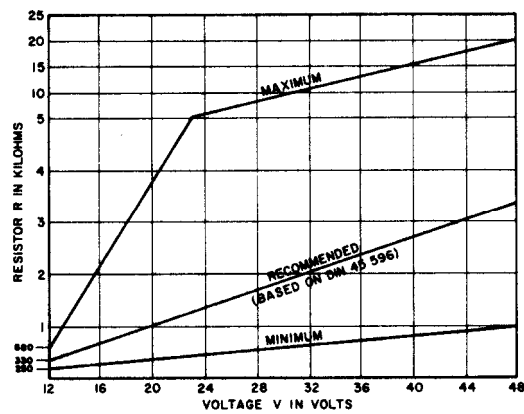

RESISTOR R VALUES
FIGURE 7

better to assure close matching, although the absolute value is not critical. Note that the two-resistor phantom power supply (Figure 5) presents a load equal to 4R, paralleled with the mixer input impedance, to the SM80. If the combined parallel load is below 800 ohms, the transformer configuration (Figure 6) is recommended, and if the combined load is 150 ohms or less, it must be used.

If the power supply is unregulated, the power supply voltage may drop when the SM80 is connected to it, due to the added load. To account for this load, the value of R may be determined as follows. Connect a variable resistance (or resistor substitution box) in series with a 10-kilohm, 10% resistor. Connect the free end of the 10k resistor to ground and the free end of the variable resistor to B+ of the power supply. Adjust the variable resistor until 12 to 36 volts is measured across the 10k resistor. Note the actual dc supply voltage and the value of the variable resistor. Verify that the resistor value falls within the indicated range on the graph of Figure 7. The value of the variable resistor is the appropriate resistance R for use in Figure 6. If the configuration in Figure 5 is to be used, double the resistor value (2R). Voltages as low as 10 Vdc minimum as measured at the microphone connector are acceptable. The nominal current drain at 10 Vdc is 1.1 mA. This is the minimum current a power supply must be able to deliver for proper operation.

For example, in mixers with 30 Vdc power supplies, the value of 2R for the configuration in Figure 4 could be 3.6k. Two 3.6k resistors should be closely matched (2% or better), and may be mounted externally with the B+ end connected to the 30V terminal. The resistors may also be mounted internally (such modifications should be performed by qualified service personnel only).

A convenient method of battery-powering the SM80 using two 9-volt batteries is shown in Figure 8. Note

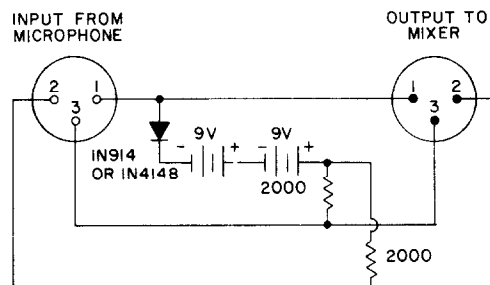

BATTERY POWER SUPPLY
FIGURE 8

that this circuit can *only* be used with balanced, floating (ungrounded), transformer-coupled input mixers such as the Shure M67 or SE30. The resistors should be 1% tolerance or better to assure close matching. With new batteries, this supply will operate an SM80 for approximately 200 hours.

LOW-FREQUENCY RESPONSE SWITCH

The SM80 has a three-position low-frequency response switch located on its handle. The switch is recessed to avoid accidental movement, but may be easily moved with the fingertips. The user may select either flat response, low-frequency rolloff of 6 dB per octave below 100 Hz, or low-frequency cutoff of 18 dB per octave below 80 Hz (see Figure 1).

ATTENUATOR RING

The SM80 has a switchable 10 dB capacitive attenuator to prevent high sound pressure levels from overloading the microphone's internal electronics. The attenuator is engaged by rotating the actuator ring directly below the grille assembly. In the "10" position, the output of the microphone is reduced by 10 dB, increasing the maximum sound pressure level at clipping by 10 dB.

The attenuator ring may be locked in either the "0" or "10" position as follows. Unscrew the grille and cartridge assembly by unscrewing counterclockwise from the top. Turn the actuator ring to the "0" or "10" position as desired. Insert the actuator ring lock (small curved piece of plastic) in the area behind the actuator ring between the pin and the edge of the slot, thereby preventing the ring from turning. Replace the grille and cartridge assembly.

The amount of attenuation can be increased by changing the value of the capacitor in the 10 dB attenuator switch assembly. Note that this change must be done carefully and with subsequent cleaning to avoid possible signal-to-noise degradation. Unscrew the grille and cartridge assembly (counterclockwise from top). Lift the 10 dB attenuator actuator ring up and over the screw threads. Grasp the center contact of the 10 dB attenuator switch assembly and lift upward to remove it. Obtain a 5% NPO monolithic ceramic capacitor (Centralab MONO-KAP CN series or equivalent) of the required value for the desired attenuation:

Attenuation	Capacitance
-15 dB	150 pF
-20 dB	270 pF
-25 dB	560 pF
-30 dB	.001 μ F

Using long-nose pliers and a low-wattage, pencil-type soldering iron, carefully remove the capacitor from the switch assembly and replace it with the new value. Take care not to touch the switch assembly with the soldering iron. To remove possible contamination, after soldering wash the entire switch assembly in a mild detergent solution, rinse it in distilled water, soak it in alcohol to remove the water, and allow it to air dry. Reassemble the SM80. Note the new attenuation value on the SM80 attenuator ring with a small label.

MIXER OVERLOAD

The SM80 output is about 15 dB higher than most dynamic microphones, in order to provide optimum signal-to-noise ratio. When used at moderate to high SPLs, this additional output may overload the mixer

input. A resistive attenuator can be inserted in the microphone line ahead of the mixer to minimize this. The Shure Model A15AS Attenuator (15, 20 or 25 dB switch selectable) is specially designed for use with condenser microphones. A convenient 15 dB attenuator design is shown in Figure 9. The resistors shown are 1/2-watt, 1% tolerance, and the circuit may be packaged in a Switchcraft S3FM adapter housing. The 15 dB attenuator can be used between the SM80 and the PS1A (or other power supply), or between the PS1A and the mixer. Two of these attenuators may be used in series to provide 30 dB of attenuation. Note that commercially available 150-ohm attenuators (such as the Shure Model A15A) are not recommended, due to loading.

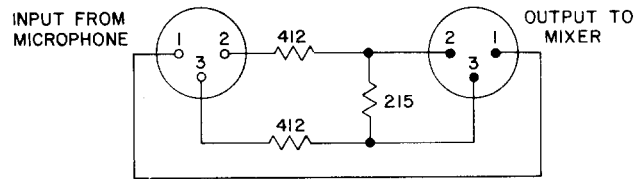

15 dB ATTENUATOR CIRCUIT
FIGURE 9

WIND NOISE

The excellent frequency response of professional condenser microphones such as the SM80 makes them quite sensitive to wind, breath and air currents from ventilation equipment. The resulting low-frequency microphone output may cause mixer overload or other problems. The Model A81G Pop Filter Grille attenuates breath popping sounds when the microphone is close-talked, and permits its use outdoors with minimal pickup of rushing and rumbling sounds.

Slip the A81G over the SM80 until the inside of the A81G touches the top of the microphone. Tighten the A81G by rotating the knurled collar clockwise from the bottom. When removing the A81G, loosen the knurled collar first (otherwise the cartridge will unscrew with the A81G).

For outdoor use under very windy conditions, the Model A81WS Heavy-Duty Windscreen is recommended.

CIRCUIT DESCRIPTION

A block diagram of the SM80 is shown in Figure 10. The capacitor cartridge is followed by a switch-controlled capacitive attenuator stage which provides for 10 dB attenuation at the cartridge output. The signal is fed to a field-effect transistor (FET) impedance conversion stage. The FET output drives an active low-frequency response (high-pass) filter controlled by a three-position switch. The filter output from a compound transistor, Class A, emitter-follower amplifier is transformer-coupled, providing a balanced output to the RFI protection filter at the microphone connector. An active, constant-current power supply circuit regulates the phantom voltage, allowing the SM80 to operate over a very wide range of voltages. A reverse voltage protection diode guards against miswired cables and equipment. The circuit contains five semiconductors to provide low noise, low distortion, wide frequency response and ultra-reliable operation over a very wide range of operating conditions.

CAPACITOR
CARTRIDGE

BALANCED
TRANSFORMER

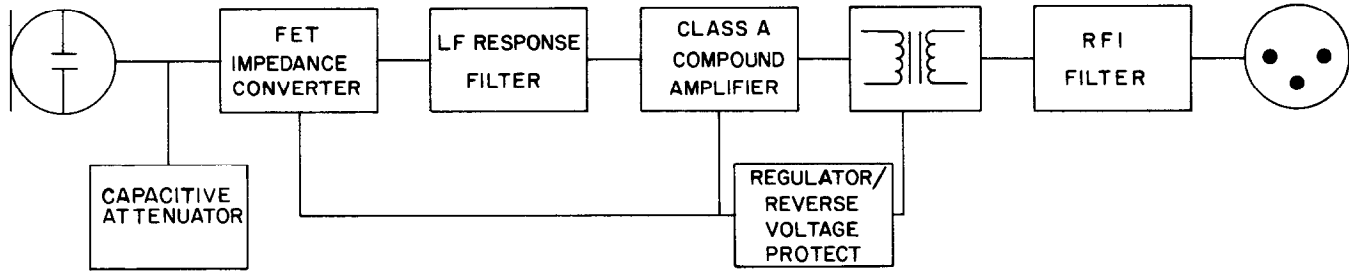

BLOCK DIAGRAM
FIGURE 10

SERVICING

TROUBLESHOOTING

Due to the high packing density and circuit complexity of the SM80, only basic servicing is recommended. The following steps should be taken if problems arise.

1. Check the power supply output voltage to the microphone. For the Shure PS1A, this should be 21.5 ± 1.5 Vdc open circuit.
2. Check the voltage on microphone connector pins 2 and 3 (at back of connector; cable connector disassembled from shell but connected to microphone). The voltage at pins 2 and 3 with reference to pin 1 should be between 10 and 48 Vdc.
3. If more than one SM80 is available, interchange cartridge assemblies to determine whether the cartridge or amplifier is at fault.

DISASSEMBLY

The SM80 can be disassembled as follows:

1. Unscrew the grille and cartridge assembly (counterclockwise from top).
2. Lift the 10 dB attenuator actuator ring up and over the screw threads.
3. Grasp the center contact of the 10 dB attenuator switch assembly and lift upward to remove it.
4. Turn the slotted head screw near the plug counterclockwise (inward) as far as it will go. Using a long-nose pliers, grasp one pin of the three-pin connector and withdraw the RFI filter and plug element from the handle.
5. Remove the low-frequency response switch knob by placing a small screwdriver or tweezers into the slot under the ridge of the knob and lifting outward.
6. Remove the small Phillips screw near the plug. Tap the cartridge end of the handle gently on a firm surface; the printed circuit board and support assembly will slide out of the cartridge end.

ARCHITECTS' SPECIFICATION

The microphone shall be a condenser microphone with a frequency response of 20 to 20,000 Hz. It shall have an omnidirectional pickup characteristic. The microphone shall have a rated output impedance of 150 ohms for connection to microphone inputs of 150 ohms or higher. The open circuit voltage shall be -65 dB (0.56 mV) (0 dB equals 1 volt per microbar).

The microphone shall contain a three-position low-

frequency response switch and a lockable 10 dB attenuator pad.

The overall dimensions shall be 212 mm (8-11/32 in.) in length by 23.5 mm (15/16 in.) in diameter. The handle diameter shall be 20.1 mm (25/32 in.). The weight shall be 230 grams (8 oz).

The microphone shall be capable of being powered by a phantom (simplex) power supply with an output of 11 to 52 Vdc, or by a mixer, audio console or tape recorder capable of supplying 11 to 52 Vdc.

The microphone shall be a Shure Model SM80.

FURNISHED ACCESSORIES

Pop Filter Grille	A81G
Swivel Adapter	A57D
10 dB Attenuator Lock	34A830

OPTIONAL ACCESSORIES

Unidirectional Microphone Cartridge	R104
Phantom Power Supply	PS1A
Heavy-Duty Windscreen	A81WS
Tripod Microphone Stand (4.3m - 14 ft)	S15
Cable (7.6m [25 ft], XLR connectors)	C25F

REPLACEMENT PARTS

Grille and Cartridge Assembly	R104A
10 dB Attenuator Actuator Ring	31B1334B
10 dB Attenuator Switch Assembly	90B2883
Low-Frequency Response Switch Knob	65A1218A
PC Board Assembly and Support	90B3820
Handle	31B1392B
RFI Filter and Plug Element	90A3622

GUARANTEE

This Shure product is guaranteed in normal use to be free from electrical and mechanical defects for a period of one year from date of purchase. Please retain proof of purchase date. This guarantee is in lieu of any and all other guarantees or warranties, express or implied, and there shall be no recovery for any consequential or incidental damages.

SHIPPING INSTRUCTIONS

Carefully repack the unit, insure it, and return it prepaid to:

Shure Brothers Incorporated
Attention: Service Department
222 Hartrey Avenue
Evanston, Illinois 60202-3696

If outside the United States, return the unit to your dealer or Authorized Shure Service Center for repair. The unit will be returned to you prepaid.