

## ULXD6 ULXD8 -- Boundary and Gooseneck Base Transmitters

---

### IMPORTANT SAFETY INSTRUCTIONS



1. READ these instructions.
2. KEEP these instructions.
3. HEED all warnings.
4. FOLLOW all instructions.
5. DO NOT use this apparatus near water.
6. CLEAN ONLY with dry cloth.
7. DO NOT block any ventilation openings. Allow sufficient distances for adequate ventilation and install in accordance with the manufacturer's instructions.
8. DO NOT install near any heat sources such as open flames, radiators, heat registers, stoves, or other apparatus (including amplifiers) that produce heat. Do not place any open flame sources on the product.
9. DO NOT defeat the safety purpose of the polarized or grounding type plug. A polarized plug has two blades with one wider than the other. A grounding type plug has two blades and a third grounding prong. The wider blade or the third prong are provided for your safety. If the provided plug does not fit into your outlet, consult an electrician for replacement of the obsolete outlet.
10. PROTECT the power cord from being walked on or pinched, particularly at plugs, convenience receptacles, and the point where they exit from the apparatus.
11. ONLY USE attachments/accessories specified by the manufacturer.
12. USE only with a cart, stand, tripod, bracket, or table specified by the manufacturer, or sold with the apparatus. When a cart is used, use caution when moving the cart/apparatus combination to avoid injury from tip-over.



13. UNPLUG this apparatus during lightning storms or when unused for long periods of time.
14. REFER all servicing to qualified service personnel. Servicing is required when the apparatus has been damaged in any way, such as power supply cord or plug is damaged, liquid has been spilled or objects have fallen into the apparatus, the apparatus has been exposed to rain or moisture, does not operate normally, or has been dropped.
15. DO NOT expose the apparatus to dripping and splashing. DO NOT put objects filled with liquids, such as vases, on the apparatus.
16. The MAINS plug or an appliance coupler shall remain readily operable.
17. The airborne noise of the Apparatus does not exceed 70dB (A).
18. Apparatus with CLASS I construction shall be connected to a MAINS socket outlet with a protective earthing connection.

19. To reduce the risk of fire or electric shock, do not expose this apparatus to rain or moisture.
20. Do not attempt to modify this product. Doing so could result in personal injury and/or product failure.
21. Operate this product within its specified operating temperature range.

**WARNING:** Voltages in this equipment are hazardous to life. No user-serviceable parts inside. Refer all servicing to qualified service personnel. The safety certifications do not apply when the operating voltage is changed from the factory setting.

	<p>This symbol indicates that dangerous voltage constituting a risk of electric shock is present within this unit.</p>
	<p>This symbol indicates that there are important operating and maintenance instructions in the literature accompanying this unit.</p>

## Quickstart Instructions

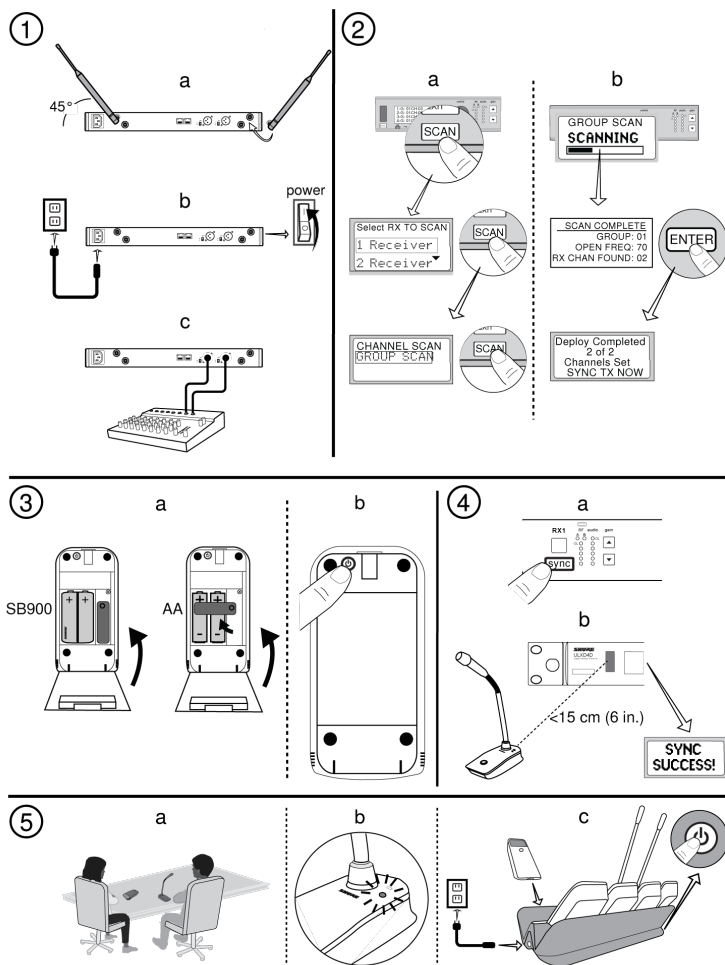

---

## General Description

ULX-D series boundary and gooseneck base transmitters add new designs to Shure's breakthrough ULX-D wireless line. Boundary and gooseneck base transmitters offer cable-free flexibility for corporate conference rooms, government facilities, educational institutions, A/V conferencing, and live sound reinforcement. Use Shure Wireless Workbench<sup>®</sup> software and networked docking stations to simplify transmitter configuration and monitor charging status.

Both transmitters run on rechargeable or AA batteries and can be monitored using external control systems, such as AMX or Crestron. ULX-D systems also offer audio signal encryption, high-density mode, and Dante<sup>™</sup> digital networking for multi-channel audio over Ethernet.

---

## Included Components

- AA Batteries
- 

## Optional Accessories

4-bay networked docking station for gooseneck and boundary microphones	SBC450
8-bay networked docking station for gooseneck and boundary microphones	SBC850
8-Bay Shure Battery Charger	SBC800
6' USB-A cable with wall plug for charging Wireless Transmitters	SBC10-USB-A
Shure Lithium-Ion Rechargeable Battery	SB900A

# Transmitter Controls and Connectors

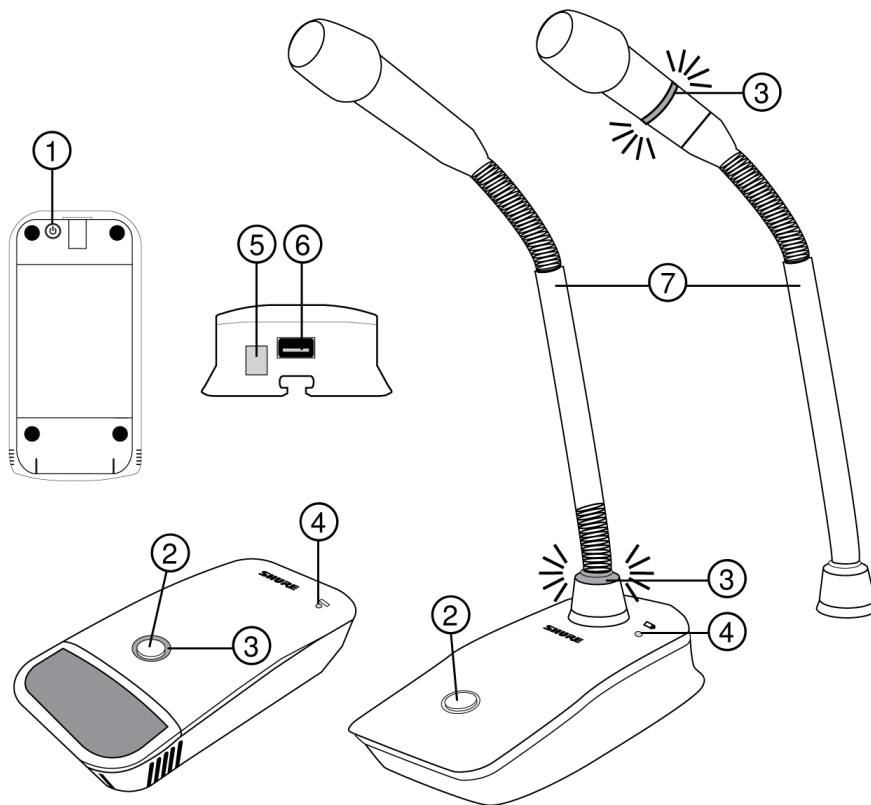

## ① Power Button

Press to power on; press and hold to power off.

## ② Mute/Active Button

Four settings are available for the mute/active button:

- Toggle: Press to switch between active and mute states
- Push-to-Mute: Hold button to mute microphone
- Push-to-Talk: Hold button to activate microphone
- Disabled: Button functionality off

## ③ Mute LED

Indicates whether microphone is active or muted. The following settings are available:

Active	Muted
Green*	Red*
Red	Off
Red	Flashing red

\*MX400R series gooseneck microphones (red LED) do not offer this setting.

#### ④ Low-Battery LED

- Off = More than 30 minutes of battery life remain
- On (red) = Less than 30 minutes of battery life remain
- On (green) = Microphone docked on charging station
- On (amber) = Battery is missing or is not inserted correctly

#### ⑤ Infrared (IR) Port

Align with receiver IR port to send settings to transmitter.

#### ⑥ Charge Connector

Connects to networked chargers and USB power supply.

#### ⑦ Gooseneck Microphone

ULXD8 base fits 5", 10", and 15" Microflex series microphones. Gooseneck microphones are available in single or dualflex models and with bi-color or red-only LEDs.

---

## Connecting Gooseneck Microphone to ULXD8 Base

ULXD8 base transmitters fit 5", 10", and 15" Microflex series gooseneck microphones, available in single and dualflex models.

Connect microphone to base as shown.

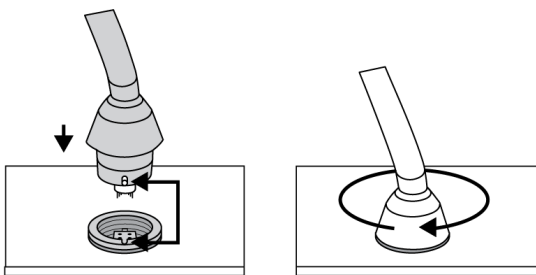



---

## Boundary Microphone Placement

The boundary transmitter sits on a table or desk to transmit speech while discreetly blending into any conference environment. Cardioid and omnidirectional versions are available.

For best low-frequency response and rejection of background noise, place the microphone on a large, flat surface, such as a floor, table, or lectern.

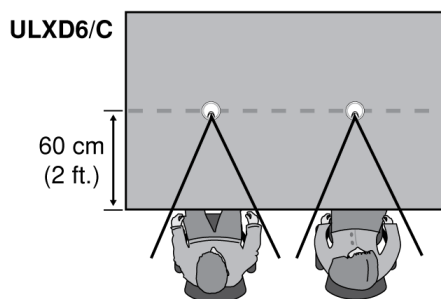
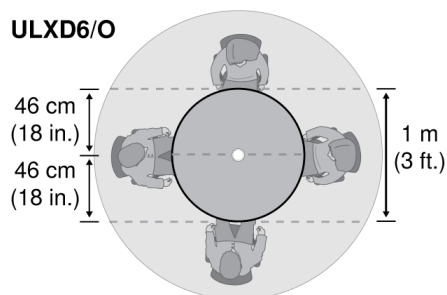
To reduce reverberance, avoid reflective surfaces above or to the side of the microphone, such as beveled sides of pulpits or overhanging shelves.



## Batteries

Boundary and gooseneck base transmitters can be powered by Shure SB900A batteries or two AA batteries (included).

The receiver front panel displays battery charge level in hours/minutes for Shure batteries and in bars for AA batteries. For accurate monitoring, set battery type in the IR Presets menu using the receiver front panel or Wireless Workbench and perform an IR sync.

Menu path: IR PRESETS > GOOSENECK / BOUNDARY > BATTERY

## Installation

1. Open the battery door.
2. Insert one Shure battery or two AA batteries. Align +/- terminals on batteries as shown. For AA batteries, rotate the rubber piece to hold batteries in place.
3. Close the battery door until it latches.

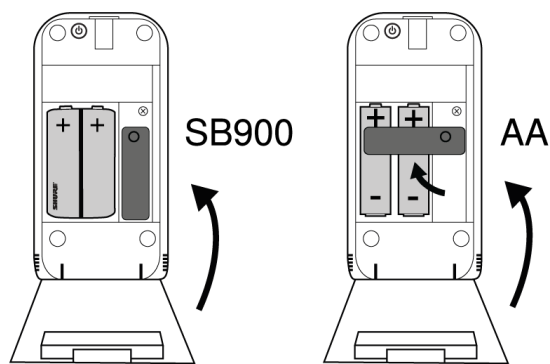

Use the small screw to the right of the batteries to secure the battery door against tampering, if necessary.

1. Open the battery door.
2. Use a screwdriver to remove the screw to the right of the battery.
3. Close the battery door.
4. Insert and tighten the screw using a screwdriver.

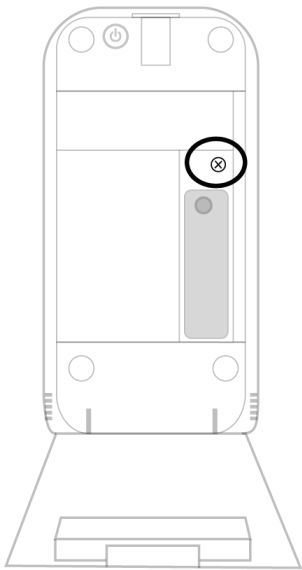

## Shure Rechargeable Batteries

The receiver home screen displays the number of hours and minutes remaining for rechargeable batteries. If using a networked docking station, Wireless Workbench displays battery information for all docked transmitters.

Detailed information for rechargeable batteries is displayed in the receiver BATTERY INFO menu.

**HEALTH:** Displays battery health as a percentage of the charge capacity of a new battery.

**CHARGE:** Percentage of a full charge

**CYCLES:** Number of times the battery has been charged

**TEMP:** Battery temperature in Celsius and Fahrenheit

## Charging

Charge transmitters with Shure rechargeable batteries in a networked docking station.

**Note:** Turning off a networked docking station also turns off any docked transmitters. Transmitters will resume charging when the power is restored.

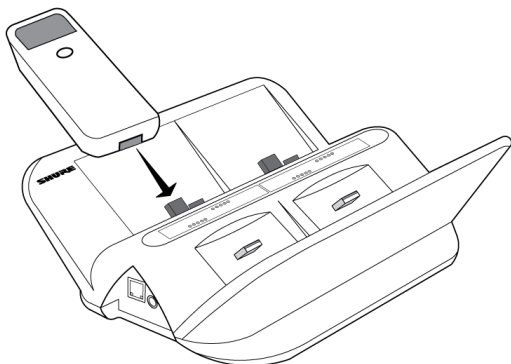

To provide power during operation, connect to an optional Shure USB power supply (SBC10-USB-A).





The SBC10 power supply and the SBC450 and SBC850 docking stations fully charge Shure SB900A batteries in about three hours.

## Battery Runtime Charts



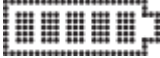
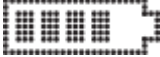

For AA batteries, the battery icon on the receiver front panel indicates battery charge.

The following tables display the approximate hours and minutes remaining (hh:mm) for each battery indicator.

### Alkaline

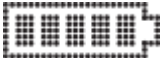
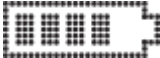



Battery Life	10 mW
	8:00 to 5:55
	5:55 to 3:50
	3:50 to 1:45
	1:45 to 0:45
	0:45 to 0:15
	0:15 to 0:00

### NiMH

Battery Life	10 mW
	10:00 to 7:15
	7:15 to 4:30
	4:30 to 1:45
	1:45 to 0:45
	0:45 to 0:15
	0:15 to 0:00

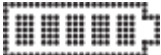
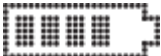
### Li-primary



<b>Battery Life</b>	<b>10 mW</b>
	15:00 to 10:35
	10:35 to 6:10
	6:10 to 1:45
	1:45 to 0:45
	0:45 to 0:15
	0:15 to 0:00

## Changing Transmitter Settings

Each transmitter has the following adjustable settings:

- Mute button and mute LED behavior or brightness
- High-pass filter
- RF power
- Power lock
- Initial state from charger
- Battery type
- Device name
- Channel name
- Frequency
- Normal or High-Density mode
- Boundary and gooseneck offset

There are three ways to change transmitter settings:

### Wireless Workbench and Networked Docking Station (recommended)

**Required equipment:** Networked docking station, computer with Wireless Workbench installed, and transmitter

1. Place transmitters on charger. Check that charger is connected to network and to Wireless Workbench.
2. Open the Item Properties for the charger in Wireless Workbench.
3. Select one or multiple transmitters.
4. Make changes to transmitter settings and click Apply. Transmitters are now ready to use.

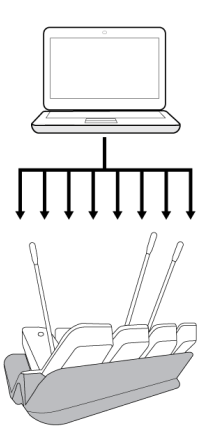

## Wireless Workbench and IR Sync

**Required equipment:** Computer with Wireless Workbench installed, receiver, and transmitter

1. Ensure that the receiver is connected to the network and to Wireless Workbench.
2. From Wireless Workbench, access the Properties Panel for the receiver.
3. Navigate to IR Presets and set the transmitter parameters.
4. Sync the transmitter and receiver to send the settings to the transmitter.

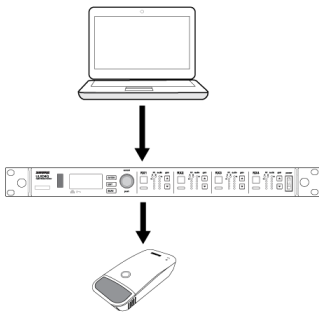

## Receiver Front Panel

**Required equipment:** Receiver and transmitter

1. Use receiver front panel and control wheel to change transmitter settings. See receiver user guide for detailed menu structure.
2. Press enter on receiver to save changes.
3. Press sync.
4. Align the receiver and transmitter IR windows until the receiver IR window illuminates red.
5. When complete, SYNC SUCCESS! appears.

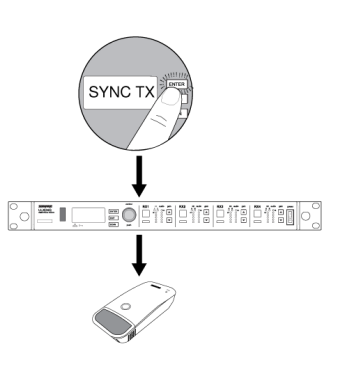

**Note:** If using a QLX-D receiver, you must use Wireless Workbench to make changes to transmitter settings.

## Using QLX-D with a Shure ULX-D System

Transmitters and receivers from QLX-D and ULX-D component groups can be paired to form audio channels.

To ensure functionality, use the following settings on receivers and transmitters:

- Encryption set to Off
- High Density Mode set to Off (ULX-D receiver)
- Manually tune the receiver and transmitter to the same frequency. IR sync between QLX-D and ULX-D components is not supported.

To create an audio channel, manually set the receiver frequency to match the frequency of the transmitter.

If using ULXD6 or ULXD8 transmitters with a QLX-D receiver, you can only make changes to transmitter presets using Wireless Workbench.

1. Open receiver properties in WWB.
2. Make changes to transmitter presets and click Apply. The new settings will be sent to the QLX-D receiver.
3. On the receiver front panel, hold enter while pressing menu to enter the advanced menu.
4. Press menu to advance to Preset bn gn. The IR window will flash.

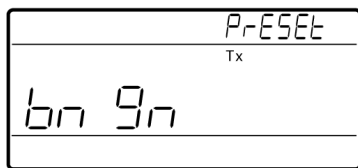

5. Align the transmitter IR window with the receiver to send the presets to the transmitter.

**Important:** All QLX-D and ULX-D components must use 2.0 firmware or greater for proper functionality.

## Mute/Active Button

The button is configured to toggle between Mute and Active. The following options are available:

- Toggle: Press button to mute microphone, press again to pass audio
- Push-to-Talk: Hold button to pass audio
- Push-to-Mute: Hold button to mute microphone
- Disabled: Button functionality off

Change button behavior using Wireless Workbench or the receiver front panel.

Menu path: IR PRESETS > GOOSENECK / BOUNDARY > MUTE BUTTON BEHAVIOR

**Note:** When the mute/active button is set to Disabled, the transmitter will still send TPCI data if the button is pressed.

## High-Pass Filter

Each transmitter contains a high-pass filter.

The high-pass filter:

- attenuates frequencies below 150 Hz by 12 dB per octave
- reduces low-frequency noise caused by table vibration or air handling systems

Adjust high-pass filter settings using Wireless Workbench or the receiver front panel.

Menu path: IR PRESETS > GOOSENECK / BOUNDARY > HIGH PASS

## Transmitter RF Power

Reference the following table for setting RF Power:

RF Power Setting	System Range	Application
1 mW	33 m (100 ft.)	For increased channel reuse at close distances
10 mW	100 m (330 ft.)	Typical setups
20 mW	>100 m (330 ft.)	For hostile RF environments or long-distance applications

Menu path: IR PRESETS > GOOSENECK / BOUNDARY > RF POWER

**Note:** Using the 20 mW setting decreases the transmitter battery runtime and reduces the number of compatible systems.

## Locking Transmitter Controls

Boundary and gooseneck base transmitters have a power lock to prevent accidental or unauthorized changes to the transmitter. When the power lock is on, the transmitter's power switch is disabled.

To unlock, use receiver front panel or Wireless Workbench.

Menu path: IR PRESETS > GOOSENECK / BOUNDARY > POWER LOCK

Attempting to access a locked feature will display the following message on the receiver front panel:



---

## Setting Initial State From Charger

Use the receiver front panel or Wireless Workbench to control a transmitter's state after you remove it from a networked docking station.

- Active: On and passing audio
- Muted: On but the audio is muted
- Off: Power is off

Menu path: IR PRESETS > GOOSENECK / BOUNDARY > INITIAL STATE FROM CHARGER

**Note:** If Mute Button Behavior is set to Push-to-Talk and Initial State From Charger is set to Active, the transmitter will only pass audio when you push the mute button. Make sure to coordinate settings for Mute Button Behavior and Initial State From Charger.

---

## Audio Signal Encryption

When encryption is enabled, the receiver generates a unique encryption key which is shared with the transmitter during an IR sync. Transmitters and receivers that share an encryption key form a protected audio path, preventing unauthorized access from other receivers.

Enable encryption using Wireless Workbench or the receiver front panel. For more details, see the user guide for your receiver.

### Encrypting a Single Transmitter to a Single Receiver

1. From the receiver menu: DEVICE UTILITIES > ENCRYPTION > ON (Auto)
2. Press ENTER.
3. Perform an IR Sync to share the encryption key with the selected transmitter.

### Removing Encryption

1. From the receiver menu: DEVICE UTILITIES > ENCRYPTION > OFF
2. Press ENTER.
3. IR Sync the transmitter and receiver to clear the encryption key.

**Note:** If multiple transmitters are encrypted to a single receiver, each transmitter must be IR synced to clear the encryption key.

## BN and GN OFFSET

BN OFFSET and GN OFFSET compensate for signal level differences between transmitters that share the same receiver channel. For normal gain adjustments, use the receiver gain buttons.

Set the offset gain on a low signal level transmitter to match a louder transmitter: IR PRESETS > GOOSENECK / BOUNDARY > BN OFFSET

IR PRESETS > GOOSENECK / BOUNDARY > GN OFFSET

## Transmitter Reset

Hold mute button while powering on transmitter to restore factory settings:

- Mute button: Toggle
- Mute LED: Active/Mute = Green/Red
- Mute LED with MX400R gooseneck: Active/Mute = Red/Off
- Initial state from charger: Active
- High-pass filter: Off
- RF power: 10 mW
- Battery type: Alkaline
- BN or GN offset: 0 dB
- Power lock: Off
- Mute LED brightness: Normal

## Frequency Range

Band	Frequency Range ( MHz )	Power ( mW )*
G50	470 to 534	1/10/20
G51	470 to 534	1/10/20
G52	479 to 534	1/10
H50	534 to 598	1/10/20
H51	534 to 598	1/10/20
H52	534 to 565	1/10
H53	534 to 598	1/10
J50	572 to 608; 614 to 636	1/10/20
J51	572 to 636	1/10/20

Band	Frequency Range ( MHz )	Power ( mW )*
K51	606 to 670	1/10
K52	606 to 670	1/10
L51	632 to 696	1/10/20
L52	632 to 694	1/10
L53	632 to 714	1/10/20
P51	710 to 782	1/10/20
P52	710 to 782	1/10
JB	806 to 810	1/10
Q51	794 to 806	1/10/20
S50	823 to 832; 863 to 865	1/10
X51	925 to 937.5	1/10
X52	902 to 928	0.25/10/20
X53	902 to 907.500; 915 to 928	0.25/10/20
X54	915 to 928	0.25/10/20

\*Output power delivered to the antenna port of the transmitter.

## Specifications

### ULXD6

#### Gain Adjustment Range

0 to 21 dB (in 3 dB steps)

#### Battery Type

Shure SB900/SB900A Rechargeable Li-Ion or AA batteries 1.5 V

#### Battery Runtime

@ 10 mW

Shure SB900A	Up to 9 hours 20 minutes
AA batteries	Up to 8 hours 40 minutes

See Battery Runtime Chart

### Dimensions

113.94 mm x 61.83 mm x 34.28 mm (4.48 in. x 2.43 in. x 1.35 in.) H x W x D

### Weight

241 g with AA batteries

### Operating Temperature Range

0°C (32°F) to 45°C (113°F)

### Housing

Molded Plastic

## RF Output

### Antenna Type

Integrated PIFA

### Impedance

50  $\Omega$

### Occupied Bandwidth

<200 kHz

### Modulation Type

Shure proprietary digital

### Power

1 mW, 10 mW, 20 mW

See Frequency Range and Output Power table, varies by region



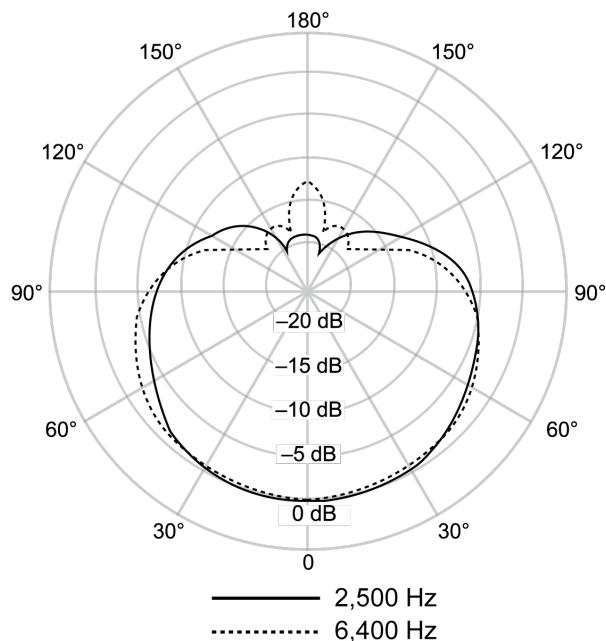
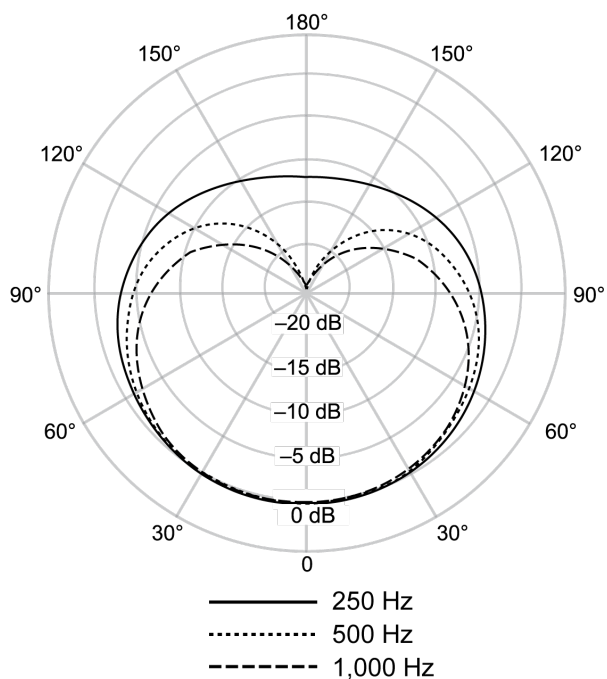

Cardioid

## ULXD8

### Gain Adjustment Range

0 to 21 dB (in 3 dB steps)

### Battery Type

Shure SB900/SB900A Rechargeable Li-Ion or AA batteries 1.5 V

### Battery Runtime

@ 10 mW

Shure SB900A	Up to 9 hours
AA batteries	Up to 8 hours 20 minutes

See Battery Runtime Chart

### Dimensions

136.94 mm x 78.27 mm x 40.77 mm (5.39 in. x 3.08 in. x 1.60 in.) H x W x D

### Weight

293 g with AA batteries

### Operating Temperature Range

0°C (32°F) to 45°C (113°F)

## Housing

Molded Plastic

## Audio Input

### Microphone Connector

6-pin connector for Shure MX405/10/15

### Configuration

Unbalanced

### Impedance

>20 k $\Omega$

## RF Output

### Antenna Type

Integrated PIFA

### Impedance

50  $\Omega$

### Occupied Bandwidth

<200 kHz

### Modulation Type

Shure proprietary digital

### Power

1 mW, 10 mW, 20 mW

See Frequency Range and Output Power table, varies by region

---

## Certifications

This device complies with part 15 of the FCC Rules. Operation is subject to the following two conditions: (1) This device may not cause harmful interference, and (2) this device must accept any interference received, including interference that may cause undesired operation.

Certified under FCC Part 74.

Certified by IC in Canada under RSS-102 and RSS-210.

Certified by IC in Canada under RSS-247 and RSS-GEN.

**IC:** 616A-ULXD6G50, 616A-ULXD6H50, 616A-ULXD6J50, 616A-ULXD6X52, 616A-ULXD8G50, 616A-ULXD8H50, 616A-ULXD8J50, 616A-ULXD8X52.

**FCC:** DD4ULXD6G50, DD4ULXD6H50, DD4ULXD6J50, DD4ULXD6X52, DD4ULXD8G50, DD4ULXD8H50, DD4ULXD8J50, DD4ULXD8X52.

This product meets the Essential Requirements of all relevant European directives and is eligible for CE marking.

This device complies with Industry Canada licence-exempt RSS standard(s). Operation of this device is subject to the following two conditions: (1) this device may not cause interference, and (2) this device must accept any interference, including interference that may cause undesired operation of the device.

Le présent appareil est conforme aux CNR d'Industrie Canada applicables aux appareils radio exempts de licence. L'exploitation est autorisée aux deux conditions suivantes : (1) l'appareil ne doit pas produire de brouillage, et (2) l'utilisateur de l'appareil doit accepter tout brouillage radioélectrique subi, même si le brouillage est susceptible d'en compromettre le fonctionnement.

**Note:** EMC conformance testing is based on the use of supplied and recommended cable types. The use of other cable types may degrade EMC performance.

The CE Declaration of Conformity can be obtained from: [www.shure.com/europe/compliance](http://www.shure.com/europe/compliance)

Authorized European representative:

Shure Europe GmbH

Headquarters Europe, Middle East & Africa

Department: EMEA Approval

Jakob-Dieffenbacher-Str. 12

75031 Eppingen, Germany

Phone: +49-7262-92 49 0

Fax: +49-7262-92 49 11 4

Email: [info@shure.de](mailto:info@shure.de)

---

## Information to the user

This equipment has been tested and found to comply with the limits for a Class B digital device, pursuant to Part 15 of the FCC Rules. These limits are designed to provide reasonable protection against harmful interference in a residential installation. This equipment generates uses and can radiate radio frequency energy and, if not installed and used in accordance with the instructions, may cause harmful interference to radio communications. However, there is no guarantee that interference will not occur in a particular installation. If this equipment does cause harmful interference to radio or television reception, which can be determined by turning the equipment off and on, the user is encouraged to try to correct the interference by one or more of the following measures:

- Reorient or relocate the receiving antenna.
- Increase the separation between the equipment and the receiver.
- Connect the equipment to an outlet on a circuit different from that to which the receiver is connected.
- Consult the dealer or an experienced radio/TV technician for help.

## LICENSING INFORMATION

Licensing: A ministerial license to operate this equipment may be required in certain areas. Consult your national authority for possible requirements. Changes or modifications not expressly approved by Shure Incorporated could void your authority to operate the equipment. Licensing of Shure wireless microphone equipment is the user's responsibility, and licensability depends on the user's classification and application, and on the selected frequency. Shure strongly urges the user to contact the appropriate telecommunications authority concerning proper licensing, and before choosing and ordering frequencies.

**WARNING:** Danger of explosion if incorrect battery replaced. Operate only with AA batteries.

## WARNING

- Battery packs may explode or release toxic materials. Risk of fire or burns. Do not open, crush, modify, disassemble, heat above 140°F (60°C), or incinerate.
- Follow instructions from manufacturer
- Only use Shure charger to recharge Shure rechargeable batteries
- **WARNING:** Danger of explosion if battery incorrectly replaced. Replace only with same or equivalent type.
- Never put batteries in mouth. If swallowed, contact your physician or local poison control center
- Do not short circuit; may cause burns or catch fire
- Do not charge or use battery packs other than Shure rechargeable batteries
- Dispose of battery packs properly. Check with local vendor for proper disposal of used battery packs.
- Batteries (battery pack or batteries installed) shall not be exposed to excessive heat such as sunshine, fire or the like

**WARNING:** This product contains a chemical known to the State of California to cause cancer and birth defects or other reproductive harm.

Please follow your regional recycling scheme for batteries, packaging, and electronic waste.